



Parker Global Air Preparation System



DECLARATION OF COMPLIANCE (ROHS)

European Directive 2002/95/EC - RoHS (**R**estriction of use **o**f certain **H**azardous **S**ubstances in electrical and electronic equipment), restricts the use of the 6 substances below in the manufacture of specified electrical equipment.

Substance	Concentration
LEAD:	Product containing lead and its compounds (except for application of lead as an alloying element by weight in steel up to 0.35%, in aluminum up to 0.4% and in copper alloys up to 4% and in Circuit Board solder) must not exceed 0.1% by weight.
MERCURY:	The concentration level must not exceed 0.1% by weight.
CADMIUM:	The concentration level must not exceed 0.01% by weight.
HEXAVALENT CHROMIUM:	This is a corrosive protective finish used on our product line. Were this finish is utilized the Chromate solution is Hexavalent (Chrome 6) free.
POLYBROMINATED BIPHENYLS (PBB):	The concentration level must not exceed 0.1% by weight. This substance is not known to be in any of our products.
POLYBROMINATED DIPHENYL ETHERS (PBDE):	The concentration level must not exceed 0.1% by weight. This substance is not known to be in any of our products.

This information applies to product sold on or after 1st July, 2006

WARNING

FAILURE OR IMPROPER SELECTION OR IMPROPER USE OF THE PRODUCTS AND/OR SYSTEMS DESCRIBED HEREIN OR RELATED ITEMS CAN CAUSE DEATH, PERSONAL INJURY AND PROPERTY DAMAGE.

This document and other information from Parker Hannifin Corporation, its subsidiaries and authorized distributors provide product and/or system options for further investigation by users having technical expertise. It is important that you analyze all aspects of your application including consequences of any failure, and review the information concerning the product or system in the current product catalog. Due to the variety of operating conditions and applications for these products or systems, the user, through its own analysis and testing, is solely responsible for making the final selection of the products and systems and assuring that all performance, safety and warning requirements of the application are met.

The products described herein, including without limitation, product features, specifications, designs, availability and pricing, are subject to change by Parker Hannifin Corporation and its subsidiaries at any time without notice.

Offer of Sale

The items described in this document are hereby offered for sale by Parker Hannifin Corporation, its subsidiaries or its authorized distributors. This offer and its acceptance are governed by the provisions stated on the separate page of this document entitled "Offer of Sale".

Introduction	4-13
Combos	
P31 Mini Series	14
P32 Compact Series	15
P33 Standard Series	16
Dimensions	17
Filters	
P31 Mini Series	18-19
P32 Compact Series	20-21
P33 Standard Series	22-23
Coalescing & Adsorber Filters	
P31 Mini Series	24-25
P32 Compact Series	26-27
P33 Standard Series	28-29
Regulators	
P31 Mini Series	30-31
P31 Mini Common Port Regulator	32-33
P32 Compact Series	34-35
P32 Compact Common Port Regulator	36-37
P33 Standard Series	38-39
Filter / Regulators	
P31 Mini Series	40-41
P32 Compact Series	42-42
P33 Standard Series	44-45
Lubricators	
P31 Mini Series	46-47
P32 Compact Series	48-49
P33 Standard Series	50-51
Proportional Regulators	
P31 Mini Series & P32 Compact Series	52-61
Combined Soft Start / Dump Valve	62-63
Dump Valve	64-65
Soft Start Valve	66-67
Solenoid Operators	68-69
Safety Lockout Valve	70
Modular Ball Valves	71
Manifold Blocks	72
Accessories	
P31 Mini Series	73
P32 Compact Series	74
P33 Standard Series	75
Accessories Kits	76-78
Safety Guide	80-81
Offer of Sale	82



Parker Global Air Preparation System

Global.
Economical.
Modular.



*Performance you need,
wherever you need it.*

The comprehensive Global Air Preparation System is available in three body sizes with either BSPP, BSPT, or NPT to accommodate thread type requirements.

Full featured filters, regulators, filter/regulators, and lubricators are available with a wide range of standard options to meet air preparation needs.

Individual units can easily be assembled into various combinations, utilizing patented modular lightweight body connectors.

www.parker.com/globalfrl

Comprehensive Offering



P31 Mini Series
1/4" ports
40mm body width



P32 Compact Series
1/4", 3/8" and 1/2"
60mm body width



P33 Standard Series
1/2" and 3/4"
73mm body width



Filters

- 5µ particulate, 1.0µ and 0.01µ coalescing, and adsorber available as standard
- Transparent or metal bowl with manual or auto float drains standard



Regulators

- Available as stand alone, common port and electronic proportional
- Both relieving and non-relieving versions available



Filter / Regulators

- Compact design for space savings
- Available with all the same standard options as the filters and regulators



Lubricators

- Proportional oil delivery over a wide range of air flows
- Fill under pressure



Combinations

- Compact design for space savings
- Easily assembled
- Many configurations available



Accessories

- Solenoid operated soft start, quick dump, and soft start/quick dump valves
- Manifold blocks
- Shut-off valves (both slide and ball type)
- Repair kits, gauges, etc.

Together we can power your application with clean, dry air

Fast cycle times, high product quality, and low downtime all require a clean, dry pneumatic system to function properly. Parker has what it takes to make sure pneumatic systems perform at their best.

Clean, dry pneumatic systems with Parker Global Air Preparation

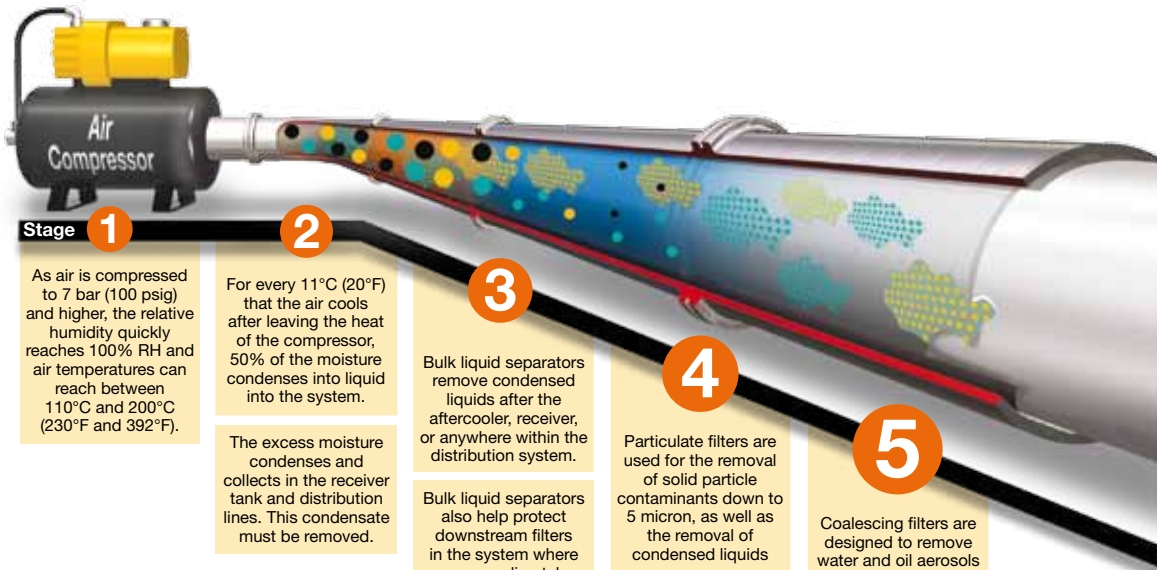

Stage 1

As air is compressed to 7 bar (100 psig) and higher, the relative humidity quickly reaches 100% RH and air temperatures can reach between 110°C and 200°C (230°F and 392°F).

2

For every 11°C (20°F) that the air cools after leaving the heat of the compressor, 50% of the moisture condenses into liquid into the system.

3

Bulk liquid separators remove condensed liquids after the aftercooler, receiver, or anywhere within the distribution system.

4

Particulate filters are used for the removal of solid particle contaminants down to 5 micron, as well as the removal of condensed liquids

5

Coalescing filters are designed to remove water and oil aerosols (not vapor) and particulate from air streams down to 0.01 micron in size.

The excess moisture condenses and collects in the receiver tank and distribution lines. This condensate must be removed.

Bulk liquid separators also help protect downstream filters in the system where excess cooling takes place.

Note: Water and oil, in vapor form, pass through general purpose particulate filters.

This type of filter should be used as a prefilter for the coalescing (oil removal) filter.

Installed in pairs, Particulate and Coalescing filters ensure a continuous supply of high quality air.

- Key**
- Particulate
 - Oil
 - Water
 - Oil Vapor
 - Water Vapor

						
Stages	1 2	3	4	5	6	7
Function	Air Compressor	Bulk Liquid Removal	Particulate Filtration	Coalescing Filtration	Air Dryers	Hydrocarbon Removal
Application	All pneumatic systems	Basic pneumatic systems	Basic pneumatic systems	Systems requiring highest quality air.	Systems requiring air with reduced moisture content	Systems requiring highest quality air for critical applications
Description	Air leaving the compressor room at 93°C (200°F) releases 95% of its moisture into the piping system when it cools to 38°C (100°F)	Removes bulk liquid contamination and protects filters where excess cooling takes place in the distribution piping	Removes solid particulates down to 5 micron, and the separation of bulk contaminants.	Removes liquid aerosols and submicron particulates (not vapor) down to 0.01 micron.	Removes water vapor from air stream. Dew point reduced down to 4°C (40°F) (refrigeration) or -40°C (-40°F) (desiccant).	Removal of odors and trace vapors for critical applications.
Parker Global Air Preparation Solution	Customer supplied	P3TF Bulk Liquid Separator	P31, P32, P33 Particulate Filter	P31, P32, P33 Coalescing Filter	PDRD Refrigeration Dryer P3TJ Regenerative Desiccant Dryer	P31, P32, P33 Activated Carbon (Adsorber) Filter



6

Refrigeration and desiccant dryers lower the air's dew point by removing water vapor, providing appropriately dry air for the downstream application.

7

Hydrocarbon and oil vapors are removed using filters utilizing activated carbon. Airborne hydrocarbons are often left over from the compressor oils.

A completely modular air preparation system

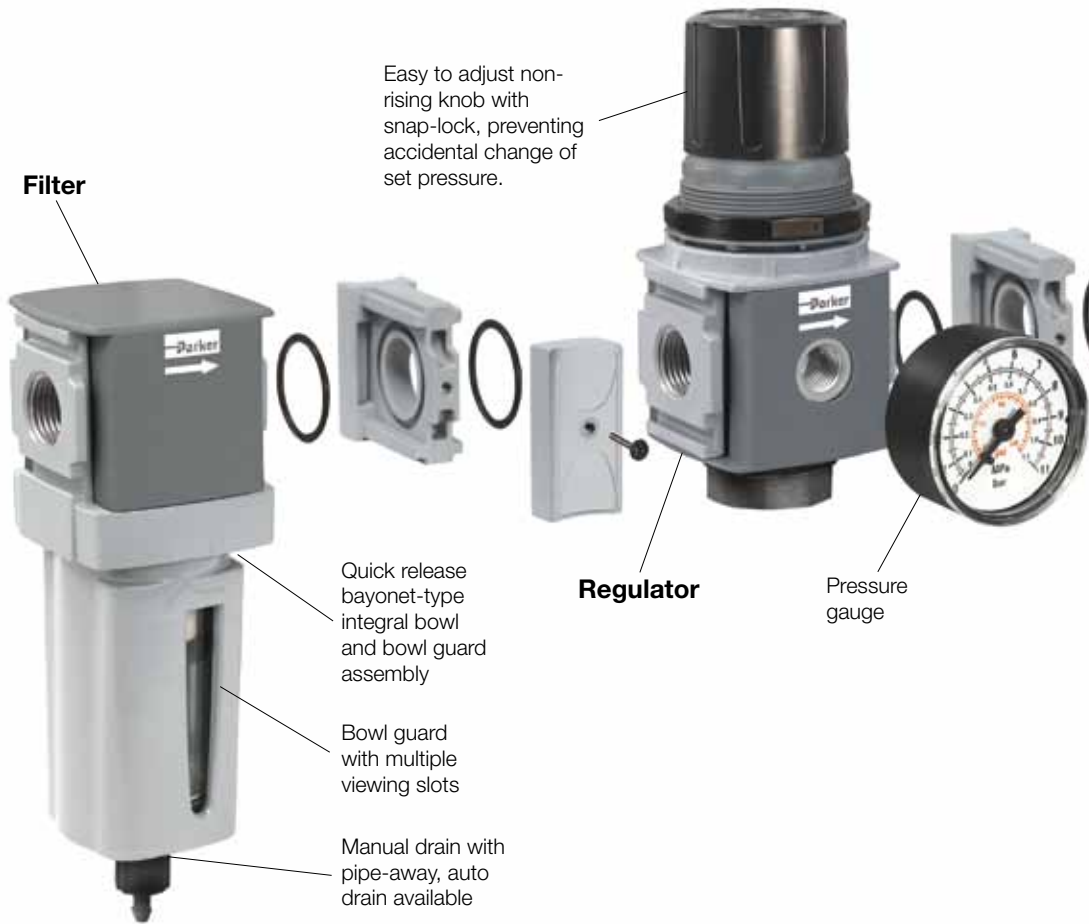

Electronic Proportional Regulator

- Electro-Pneumatic regulator
- Integrated systems control
- Accurate output pressure
- Micro parameter settings
- Selectable I/O parameters
- Quick, full flow exhaust
- LED display indicates output pressure
- No air consumption in steady state
- Multiple mounting options
- Protection to IP65



P31P Mini Series



P32P Compact Series

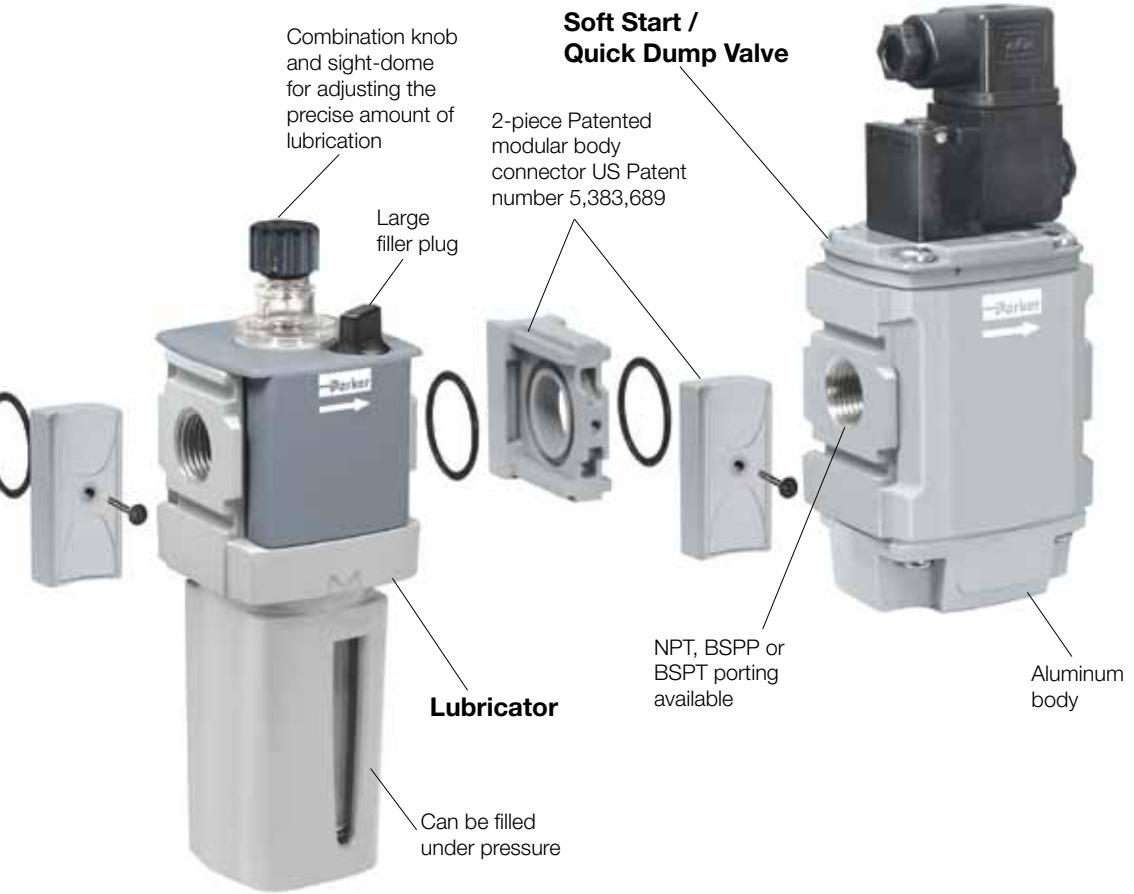

Common Port Manifold Regulators

- Multiple output pressures (P2, P3, P4, etc.) with common inlet (P1)
- Available in two sizes P31 and P32
- Balanced valve design for accurate pressure regulation
- Outlet pressure ports in front and rear of unit.
- Four spring ranges available



Air Preparation

P31 Mini Series

40mm body width

1/4" Ported

Flows up to: dm^3/s (SCFM)

Filter	12	(25)
Coalescer	2	(4.2)
Regulator	30	(64)
Filter/Regulator	14	(30)
Lubricator	13	(28)

Features:

- Space saving integral gauge
- Manifold style regulators available
- OSHA compliant shut-off valves
- Soft-Start & Quick Dump valves
- Electronic Proportional Regulator



P32 Compact Series

60mm body width

1/4", 3/8", & 1/2" Ported

Flows up to: dm^3/s (SCFM)

Filter	38	(80)
Coalescer	11	(23)
Regulator	67	(142)
Filter/Regulator	64	(136)
Lubricator	47	(100)

Features:

- Manifold style regulators available
- OSHA Compliant shut-off valves
- Soft-Start & Quick Dump valves
- Electronic Proportional Regulator



P33 Standard Series

73mm body width

1/2" & 3/4" Ported

Flows up to: dm^3/s (SCFM)

Filter	48	(102)
Coalescer	20	(42)
Regulator	100	(212)
Filter/Regulator	98	(208)
Lubricator	68	(144)

Features:

- OSHA Compliant shut-off valves
- Soft-Start & Quick Dump valves
(Utilizes P32 size only)
- Electronic proportional regulator
(Utilizes P32 size only)



Valves and Actuators

Mini Series Complimentary Products

The P31 Mini Series FRL's and accessories are well matched for use with these Parker valves and actuators.



Isys Micro



Moduflex Size 1



OSP-P



P1D



P1A

Compact Series Complimentary Products

The P32 Series FRL's & accessories are well matched for use with these Parker valves and actuators.



Isys Micro



Isys HA / HB



P1D



OSP-P

Standard Series Complimentary Products

The P33 Series FRL's & accessories are well matched for use with these Parker valves and actuators.



Isys Size 1



Isys HA / HB



P1D





OSP-P

Complete Pneumatic System

















Pressure Regulation

Accurate pressure regulation is important to control forces, speeds, torque, dispensing, processes, etc. Parker has a global solution to all of your pressure regulation needs, with support around the world.

			
Function	Single	Common Port Manifold	Electronic Proportional
Description	For pneumatic systems requiring single pressure regulation.	For pneumatic systems requiring multiple pressures for different parts of the system, yet still having a common inlet supply.	For pneumatic systems requiring an electronic to pneumatic proportional control signal. Also allows pressure regulation to be integrated into your control systems.
Parker Global Air Preparation Solution	P31R, P32R, P33R	P31H, P32H	P31P, P32P fits Compact & Standard

Accessories

Today's sophisticated pneumatic systems need more than just FRL's. Often times peripheral accessory products are needed to complete your pneumatic system. Parker has what is needed to ensure safe and reliable start-ups, shut-downs, and lockouts, etc.



						
Function	Ball Valve	Slide Valve	Soft Start / Quick Dump	Soft Start	Quick Dump	Manifold Block
Soft Start Function						
Quick Dump Function	Slow Exhaust	Slow Exhaust				
Operation	Manual Twist	Manual Slide	Solenoid or Air Pilot	Solenoid, Air Pilot, or Internal Air Pilot	Solenoid or Air Pilot	N/A
Placement	Before or after FRL or stand alone	Before or after FRL or stand alone	After FRL	After FRL	After FRL	Anywhere within FRL or stand alone
Parker Global Air Preparation Solution	P31V, P32V, P33V	P31V, P32V, P33V	P31T Mini, P32T fits Compact & Standard	P31S Mini, P32S fits Compact & Standard	P31D Mini, P32D fits Compact & Standard	P31M Mini, P33M fits Compact & Standard

Application Guide

FRL to Valve: The chart below contains recommendations for the correct selection of Global Air Preparation units to suit the number and size of valves in a typical application.

	P31 Mini Series				P32 Compact Series						P33 Standard Series					
	Number of valves that would actuate at once															
	1	2	3	4	5	6	7	8	9	10	11	12	13	14	15	16
Moduflex 1																
Isys Micro																
HB / Viking Xtreme																
Moduflex 2																
HA / Global ISO																
See Larger Parker FRL Offering																

Actuator to FRL: The chart below contains recommendations for the correct selection of Global Air Preparation units suitable for each cylinder size. If you have a tube length over 2 m, choose one tube size larger than the chart. The table is based on a Maximum cylinder speed of 0.5m/s

Cyl Ø mm Cyl Ø inches		Cylinder bore size														
		5 (5/16)	10 (7/16)	16 (9/16)	20 (3/4)	25 (1)	28 (1-1/8)	32 (1-1/4)	40 (1-1/2)	45 (1-3/4)	50 (2)	63 (2-1/2)	75 (3)	80 (3-1/4)	100 (4)	
Tube Ø mm Tube Ø inches		Tube diameter external														
		4 (5/32)	4 (5/32)	4 (5/32)	6 (1/4)	6 (1/4)	6 (1/4)	6 (1/4)	8 (5/16)	8 (5/16)	8 (5/16)	10 (3/8)	10 (3/8)	12 (1/2)	12 (1/2)	
Number of cylinders actuating at once	1															
	2															
	3															
	4															
	5															
	6															
	7															
	8															
	9															
	10															
		P31 Mini Series				P32 Compact Series				P33 Standard Series				See Larger Parker FRL Offering		
																

Note: Data listed above is simply a guideline for a typical application only. Proper sizing and correct flow requirements must be taken into account.

Popular Combinations

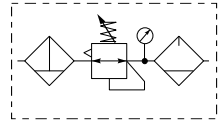

Filter + Regulator + Lubricator Combinations + Poly bowl
5 micron element, 8 bar (116 psig) Regulator + Gauge and Wall Mounting Brackets
Inlet pressure 10 bar (145 psig), Secondary pressure 6.3 bar (91.3 psig),
1 bar (14.5 psig) pressure drop.

Port size	Flow dm ³ /s (scfm)	Manual Drain	Weight	Pulse Drain	Weight
1/4"	13 27	P31CB22GEMN6LNW	0.46 kg (1.01 lbs)	P31CB22GEBN6LNW	0.46 kg (1.01 lbs)

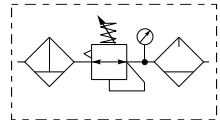

Filter/Regulator + Lubricator Combinations + Poly bowl
5 micron element, 8 bar (116 psig) Regulator + Gauge and Wall Mounting Brackets
Inlet pressure 10 bar (145 psig), Secondary pressure 6.3 bar (91.3 psig),
1 bar (14.5 psig) pressure drop.

Port size	Flow dm ³ /s (scfm)	Manual Drain	Weight	Pulse Drain	Weight
1/4"	14 28	P31CA22GEMN6LNW	0.35 kg (0.77 lbs)	P31CA22GEBN6LNW	0.35 kg (0.77 lbs)

Filter / Regulator coding
(use with codes: A M T)

Filter coding
(use with combo codes: B C D F G). For multiple filters, repeat as needed

Regulator coding
(use with combo codes: B D E)

Lubricator coding
(use with combo codes: A B C E)

Assembly configuration

<p>P 3 1</p> <table border="1"> <tr> <th colspan="2">Combination</th> <th>Thread type</th> </tr> <tr> <td>B/V + Combination</td> <td>Q</td> <td>BSPP 1</td> </tr> <tr> <td>Combination + B/V</td> <td>X</td> <td>BSPT 2</td> </tr> <tr> <td>Combination</td> <td>C</td> <td>NPT 9</td> </tr> <tr> <td>Shut off + Combination</td> <td>Y</td> <td></td> </tr> <tr> <td>Combination + Shut off</td> <td>Z</td> <td></td> </tr> </table> <table border="1"> <tr> <th colspan="2">Combination type*</th> <th>Port size</th> </tr> <tr> <td>F/R+L</td> <td>A</td> <td>F/R+Fc</td> <td>M</td> </tr> <tr> <td>F+R+L</td> <td>B</td> <td>F+Fc1+Fc</td> <td>Q</td> </tr> <tr> <td>F+Fc</td> <td>F</td> <td>F/R+Fc+Fa</td> <td>T</td> </tr> <tr> <td>F+Fc+Fa</td> <td>G</td> <td></td> <td></td> </tr> </table> <p>* Combination type F = 5µ Fc1 = 1µ Fc = .01µ Fa = Adsorber</p> <table border="1"> <tr> <th colspan="2">Bowl type</th> </tr> <tr> <td>Poly bowl with bowl guard</td> <td>G</td> </tr> <tr> <td>Metal bowl without sight gauge</td> <td>M</td> </tr> </table> <p>Note: All bowl types are the same for each component Example: If a "G" is specified for a F+L, both units would get a poly bowl with bowl guard.</p>	Combination		Thread type	B/V + Combination	Q	BSPP 1	Combination + B/V	X	BSPT 2	Combination	C	NPT 9	Shut off + Combination	Y		Combination + Shut off	Z		Combination type*		Port size	F/R+L	A	F/R+Fc	M	F+R+L	B	F+Fc1+Fc	Q	F+Fc	F	F/R+Fc+Fa	T	F+Fc+Fa	G			Bowl type		Poly bowl with bowl guard	G	Metal bowl without sight gauge	M	<table border="1"> <tr> <th colspan="2">Element</th> </tr> <tr> <td>5µ Element</td> <td>E</td> </tr> <tr> <td>0.01µ Element</td> <td>C</td> </tr> <tr> <td>1µ Element</td> <td>9</td> </tr> <tr> <td>Adsorber</td> <td>A</td> </tr> </table> <table border="1"> <tr> <th colspan="2">Drain type</th> </tr> <tr> <td>Manual drain</td> <td>M</td> </tr> <tr> <td>Pulse drain</td> <td>B</td> </tr> </table>	Element		5µ Element	E	0.01µ Element	C	1µ Element	9	Adsorber	A	Drain type		Manual drain	M	Pulse drain	B	<table border="1"> <tr> <th colspan="2">Relief / Adjustment</th> </tr> <tr> <td>Non-rising knob</td> <td>N</td> </tr> </table> <table border="1"> <tr> <th colspan="2">Adjustment Range</th> </tr> <tr> <th colspan="2">With square gauge</th> </tr> <tr> <td>2 bar (0.2 MPa) *</td> <td>2</td> </tr> <tr> <td>4 bar (0.4 MPa) *</td> <td>4</td> </tr> <tr> <td>8 bar (0.8 MPa) **</td> <td>6</td> </tr> <tr> <th colspan="2">With round gauge</th> </tr> <tr> <td>2 bar (0.2 MPa)</td> <td>Z</td> </tr> <tr> <td>4 bar (0.4 MPa)</td> <td>M</td> </tr> <tr> <td>8 bar (0.8 MPa)</td> <td>G</td> </tr> <tr> <th colspan="2">Without gauge</th> </tr> <tr> <td>2 bar (0.2 MPa)</td> <td>Y</td> </tr> <tr> <td>4 bar (0.4 MPa)</td> <td>L</td> </tr> <tr> <td>8 bar (0.8 MPa)</td> <td>N</td> </tr> </table> <p>* With 0-0.4 MPa gauge ** With 0-1.1 MPa gauge</p>	Relief / Adjustment		Non-rising knob	N	Adjustment Range		With square gauge		2 bar (0.2 MPa) *	2	4 bar (0.4 MPa) *	4	8 bar (0.8 MPa) **	6	With round gauge		2 bar (0.2 MPa)	Z	4 bar (0.4 MPa)	M	8 bar (0.8 MPa)	G	Without gauge		2 bar (0.2 MPa)	Y	4 bar (0.4 MPa)	L	8 bar (0.8 MPa)	N	<table border="1"> <tr> <th colspan="2">Lub type</th> </tr> <tr> <td>Oil mist standard sight dome</td> <td>L</td> </tr> </table> <table border="1"> <tr> <th colspan="2">Drain type</th> </tr> <tr> <td>No drain; closed end</td> <td>N</td> </tr> </table>	Lub type		Oil mist standard sight dome	L	Drain type		No drain; closed end	N	<table border="1"> <tr> <th colspan="2">Mounting</th> </tr> <tr> <td>No bracket</td> <td>A</td> </tr> <tr> <td>Port blocks & wall brkt</td> <td>C*</td> </tr> <tr> <td>Port blocks & wall brkt</td> <td>D*</td> </tr> <tr> <td>Wall bracket</td> <td>W</td> </tr> </table> <p>* For 3/8" Port Blocks please order separately. See Kits section.</p>	Mounting		No bracket	A	Port blocks & wall brkt	C*	Port blocks & wall brkt	D*	Wall bracket	W
Combination		Thread type																																																																																																													
B/V + Combination	Q	BSPP 1																																																																																																													
Combination + B/V	X	BSPT 2																																																																																																													
Combination	C	NPT 9																																																																																																													
Shut off + Combination	Y																																																																																																														
Combination + Shut off	Z																																																																																																														
Combination type*		Port size																																																																																																													
F/R+L	A	F/R+Fc	M																																																																																																												
F+R+L	B	F+Fc1+Fc	Q																																																																																																												
F+Fc	F	F/R+Fc+Fa	T																																																																																																												
F+Fc+Fa	G																																																																																																														
Bowl type																																																																																																															
Poly bowl with bowl guard	G																																																																																																														
Metal bowl without sight gauge	M																																																																																																														
Element																																																																																																															
5µ Element	E																																																																																																														
0.01µ Element	C																																																																																																														
1µ Element	9																																																																																																														
Adsorber	A																																																																																																														
Drain type																																																																																																															
Manual drain	M																																																																																																														
Pulse drain	B																																																																																																														
Relief / Adjustment																																																																																																															
Non-rising knob	N																																																																																																														
Adjustment Range																																																																																																															
With square gauge																																																																																																															
2 bar (0.2 MPa) *	2																																																																																																														
4 bar (0.4 MPa) *	4																																																																																																														
8 bar (0.8 MPa) **	6																																																																																																														
With round gauge																																																																																																															
2 bar (0.2 MPa)	Z																																																																																																														
4 bar (0.4 MPa)	M																																																																																																														
8 bar (0.8 MPa)	G																																																																																																														
Without gauge																																																																																																															
2 bar (0.2 MPa)	Y																																																																																																														
4 bar (0.4 MPa)	L																																																																																																														
8 bar (0.8 MPa)	N																																																																																																														
Lub type																																																																																																															
Oil mist standard sight dome	L																																																																																																														
Drain type																																																																																																															
No drain; closed end	N																																																																																																														
Mounting																																																																																																															
No bracket	A																																																																																																														
Port blocks & wall brkt	C*																																																																																																														
Port blocks & wall brkt	D*																																																																																																														
Wall bracket	W																																																																																																														

Popular Combinations

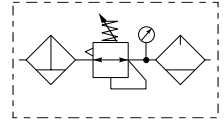

Filter + Regulator + Lubricator Combinations + Poly bowl
5 micron element, 8 bar (116 psig) Regulator + Gauge and Wall Mounting Brackets
Inlet pressure 10 bar (145 psig), Secondary pressure 6.3 bar (91.3 psig),
1 bar (14.5 psig) pressure drop.

Port size	Flow dm ³ /s	Flow (scfm)	Manual Drain	Weight	Auto Drain	Weight
1/4"	20	42	P32CB22GEMNGLNW	1.29 kg (2.84 lbs)	P32CB22GEANGLNW	1.29 kg (2.84 lbs)
3/8"	32	68	P32CB23GEMNGLNW	1.29 kg (2.84 lbs)	P32CB23GEANGLNW	1.29 kg (2.84 lbs)
1/2"	40	85	P32CB24GEMNGLNW	1.29 kg (2.84 lbs)	P32CB24GEANGLNW	1.29 kg (2.84 lbs)

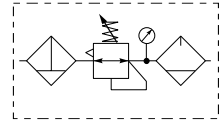

Filter/Regulator + Lubricator Combinations + Poly bowl
5 micron element, 8 bar (116 psig) Regulator + Gauge and Wall Mounting Brackets
Inlet pressure 10 bar (145 psig), Secondary pressure 6.3 bar (91.3 psig),
1 bar (14.5 psig) pressure drop.

Port size	Flow dm ³ /s	Flow (scfm)	Manual Drain	Weight	Auto Drain	Weight
1/4"	22	45	P32CA22GEMNGLNW	1.03 kg (2.27 lbs)	P32CA22GEANGLNW	1.03 kg (2.27 lbs)
3/8"	33	70	P32CA23GEMNGLNW	1.03 kg (2.27 lbs)	P32CA23GEANGLNW	1.03 kg (2.27 lbs)
1/2"	43	90	P32CA24GEMNGLNW	1.03 kg (2.27 lbs)	P32CA24GEANGLNW	1.03 kg (2.27 lbs)

Filter / Regulator coding
(use with codes: A M T)

Filter coding
(use with combo codes: B C D F G). For multiple filters, repeat as needed

Regulator coding
(use with combo codes: B D E W)

Lubricator coding
(use with combo codes: A B C E)

Assembly configuration

<p>P 3 2</p> <table border="1"> <tr> <th colspan="2">Combination</th> </tr> <tr> <td>B/V + Combination</td> <td>Q</td> </tr> <tr> <td>Combination + B/V</td> <td>X</td> </tr> <tr> <td>Combination</td> <td>C</td> </tr> <tr> <td>Shut off + Combination</td> <td>Y</td> </tr> <tr> <td>Combination + Shut off</td> <td>Z</td> </tr> </table> <table border="1"> <tr> <th colspan="2">Combination type*</th> </tr> <tr> <td>F/R+L</td> <td>A</td> </tr> <tr> <td>F+R+L</td> <td>B</td> </tr> <tr> <td>F+Fc</td> <td>F</td> </tr> <tr> <td>F+Fc+Fa</td> <td>G</td> </tr> <tr> <td>F/R+Fc</td> <td>M</td> </tr> <tr> <td>F+Fc1+Fc</td> <td>Q</td> </tr> <tr> <td>F/R+Fc+Fa</td> <td>T</td> </tr> </table> <p>* Combination type F = 5µ Fc1 = 1µ Fc = .01µ Fa = Adsorber</p> <table border="1"> <tr> <th colspan="2">Thread type</th> </tr> <tr> <td>BSPP</td> <td>1</td> </tr> <tr> <td>BSPT</td> <td>2</td> </tr> <tr> <td>NPT</td> <td>9</td> </tr> </table> <table border="1"> <tr> <th colspan="2">Port size</th> </tr> <tr> <td>1/4</td> <td>2</td> </tr> <tr> <td>3/8</td> <td>3</td> </tr> <tr> <td>1/2</td> <td>4</td> </tr> </table> <table border="1"> <tr> <th colspan="2">Bowl type</th> </tr> <tr> <td>Poly bowl with bowl guard</td> <td>G</td> </tr> <tr> <td>Metal bowl without sight gauge</td> <td>M</td> </tr> <tr> <td>Metal bowl with sight gauge</td> <td>S</td> </tr> </table> <p>Note: All bowl types are the same for each component Example: If a "G" is specified for a F+L, both units would get a poly bowl with bowl guard.</p>	Combination		B/V + Combination	Q	Combination + B/V	X	Combination	C	Shut off + Combination	Y	Combination + Shut off	Z	Combination type*		F/R+L	A	F+R+L	B	F+Fc	F	F+Fc+Fa	G	F/R+Fc	M	F+Fc1+Fc	Q	F/R+Fc+Fa	T	Thread type		BSPP	1	BSPT	2	NPT	9	Port size		1/4	2	3/8	3	1/2	4	Bowl type		Poly bowl with bowl guard	G	Metal bowl without sight gauge	M	Metal bowl with sight gauge	S	<table border="1"> <tr> <th colspan="2">Element</th> </tr> <tr> <td>5µ Element</td> <td>E</td> </tr> <tr> <td>0.01µ Element</td> <td>C</td> </tr> <tr> <td>0.01µ Element with dpi</td> <td>D</td> </tr> <tr> <td>1µ Element</td> <td>9</td> </tr> <tr> <td>1µ Element with dpi</td> <td>Q</td> </tr> <tr> <td>Adsorber</td> <td>A</td> </tr> </table> <table border="1"> <tr> <th colspan="2">Drain type</th> </tr> <tr> <td>Auto drain</td> <td>A</td> </tr> <tr> <td>Manual drain</td> <td>M</td> </tr> </table>	Element		5µ Element	E	0.01µ Element	C	0.01µ Element with dpi	D	1µ Element	9	1µ Element with dpi	Q	Adsorber	A	Drain type		Auto drain	A	Manual drain	M	<table border="1"> <tr> <th colspan="2">Relief / Adjustment</th> </tr> <tr> <td>Non-rising knob relieving</td> <td>N</td> </tr> </table> <table border="1"> <tr> <th colspan="2">Adjustment range</th> </tr> <tr> <td>With round gauge</td> <td></td> </tr> <tr> <td>2 bar; 30 psig; 0.2 MPa</td> <td>Z</td> </tr> <tr> <td>4 bar; 60 psig; 0.4 MPa</td> <td>M</td> </tr> <tr> <td>8 bar; 125 psig; 0.8 MPa</td> <td>G</td> </tr> <tr> <td>17 bar; 250 psig; 1.7 MPa</td> <td>J</td> </tr> <tr> <td>Without gauge</td> <td></td> </tr> <tr> <td>2 bar; 30 psig; 0.2 MPa</td> <td>Y</td> </tr> <tr> <td>4 bar; 60 psig; 0.4 MPa</td> <td>L</td> </tr> <tr> <td>8 bar; 125 psig; 0.8 MPa</td> <td>N</td> </tr> <tr> <td>17 bar; 250 psig; 1.7 MPa</td> <td>H</td> </tr> </table>	Relief / Adjustment		Non-rising knob relieving	N	Adjustment range		With round gauge		2 bar; 30 psig; 0.2 MPa	Z	4 bar; 60 psig; 0.4 MPa	M	8 bar; 125 psig; 0.8 MPa	G	17 bar; 250 psig; 1.7 MPa	J	Without gauge		2 bar; 30 psig; 0.2 MPa	Y	4 bar; 60 psig; 0.4 MPa	L	8 bar; 125 psig; 0.8 MPa	N	17 bar; 250 psig; 1.7 MPa	H	<table border="1"> <tr> <th colspan="2">Lub type</th> </tr> <tr> <td>Oil mist standard sight dome</td> <td>L</td> </tr> </table> <table border="1"> <tr> <th colspan="2">Drain type</th> </tr> <tr> <td>No drain; closed end</td> <td>N</td> </tr> </table>	Lub type		Oil mist standard sight dome	L	Drain type		No drain; closed end	N	<table border="1"> <tr> <th colspan="2">Mounting</th> </tr> <tr> <td>No bracket</td> <td>A</td> </tr> <tr> <td>Port blocks</td> <td>C</td> </tr> <tr> <td>Port blocks & wall brkt</td> <td>D</td> </tr> <tr> <td>Wall bracket</td> <td>W</td> </tr> </table>	Mounting		No bracket	A	Port blocks	C	Port blocks & wall brkt	D	Wall bracket	W
	Combination																																																																																																																							
B/V + Combination	Q																																																																																																																							
Combination + B/V	X																																																																																																																							
Combination	C																																																																																																																							
Shut off + Combination	Y																																																																																																																							
Combination + Shut off	Z																																																																																																																							
Combination type*																																																																																																																								
F/R+L	A																																																																																																																							
F+R+L	B																																																																																																																							
F+Fc	F																																																																																																																							
F+Fc+Fa	G																																																																																																																							
F/R+Fc	M																																																																																																																							
F+Fc1+Fc	Q																																																																																																																							
F/R+Fc+Fa	T																																																																																																																							
Thread type																																																																																																																								
BSPP	1																																																																																																																							
BSPT	2																																																																																																																							
NPT	9																																																																																																																							
Port size																																																																																																																								
1/4	2																																																																																																																							
3/8	3																																																																																																																							
1/2	4																																																																																																																							
Bowl type																																																																																																																								
Poly bowl with bowl guard	G																																																																																																																							
Metal bowl without sight gauge	M																																																																																																																							
Metal bowl with sight gauge	S																																																																																																																							
Element																																																																																																																								
5µ Element	E																																																																																																																							
0.01µ Element	C																																																																																																																							
0.01µ Element with dpi	D																																																																																																																							
1µ Element	9																																																																																																																							
1µ Element with dpi	Q																																																																																																																							
Adsorber	A																																																																																																																							
Drain type																																																																																																																								
Auto drain	A																																																																																																																							
Manual drain	M																																																																																																																							
Relief / Adjustment																																																																																																																								
Non-rising knob relieving	N																																																																																																																							
Adjustment range																																																																																																																								
With round gauge																																																																																																																								
2 bar; 30 psig; 0.2 MPa	Z																																																																																																																							
4 bar; 60 psig; 0.4 MPa	M																																																																																																																							
8 bar; 125 psig; 0.8 MPa	G																																																																																																																							
17 bar; 250 psig; 1.7 MPa	J																																																																																																																							
Without gauge																																																																																																																								
2 bar; 30 psig; 0.2 MPa	Y																																																																																																																							
4 bar; 60 psig; 0.4 MPa	L																																																																																																																							
8 bar; 125 psig; 0.8 MPa	N																																																																																																																							
17 bar; 250 psig; 1.7 MPa	H																																																																																																																							
Lub type																																																																																																																								
Oil mist standard sight dome	L																																																																																																																							
Drain type																																																																																																																								
No drain; closed end	N																																																																																																																							
Mounting																																																																																																																								
No bracket	A																																																																																																																							
Port blocks	C																																																																																																																							
Port blocks & wall brkt	D																																																																																																																							
Wall bracket	W																																																																																																																							

Popular Combinations

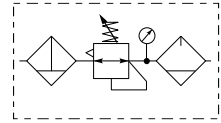

Filter + Regulator + Lubricator Combinations + Poly bowl
5 micron element, 8 bar (116 psig) Regulator + Gauge and Wall Mounting Brackets
Inlet pressure 10 bar (145 psig), Secondary pressure 6.3 bar (91.3 psig),
1 bar (14.5 psig) pressure drop.

Port size	Flow dm ³ /s (scfm)	Manual Drain	Weight	Auto Drain	Weight
1/2"	43 90	P33CB24GEMNGLNW	1.84 kg (4.06 lbs)	P33CB24GEANGLNW	1.84 kg (4.06 lbs)
3/4"	52 110	P33CB26GEMNGLNW	1.84 kg (4.06 lbs)	P33CB26GEANGLNW	1.84 kg (4.06 lbs)

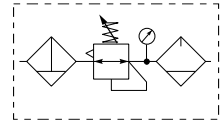

Filter/Regulator + Lubricator Combinations + Poly bowl
5 micron element, 8 bar (116 psig) Regulator + Gauge and Wall Mounting Brackets
Inlet pressure 10 bar (145 psig), Secondary pressure 6.3 bar (91.3 psig),
1 bar (14.5 psig) pressure drop.

Port size	Flow dm ³ /s (scfm)	Manual Drain	Weight	Auto Drain	Weight
1/2"	52 110	P33CA24GEMNGLNW	1.51 kg (3.33 lbs)	P33CA24GEANGLNW	1.51 kg (3.33 lbs)
3/4"	71 150	P33CA26GEMNGLNW	1.51 kg (3.33 lbs)	P33CA26GEANGLNW	1.51 kg (3.33 lbs)

Filter / Regulator coding
(use with codes: A M T)

Filter coding (use with combo codes: B C D F G). For multiple filters, repeat as needed	Regulator coding (use with combo codes: B D E W)	Lubricator coding (use with combo codes: A B C E)	Assembly configuration																																																		
<p>Element</p> <table border="1"> <tr><td>5µ Element</td><td>E</td></tr> <tr><td>0.01µ Element</td><td>C</td></tr> <tr><td>0.01µ Element with dpi</td><td>D</td></tr> <tr><td>1µ Element</td><td>9</td></tr> <tr><td>1µ Element with dpi</td><td>Q</td></tr> <tr><td>Adsorber</td><td>A</td></tr> </table> <p>Drain type</p> <table border="1"> <tr><td>Auto drain</td><td>A</td></tr> <tr><td>Manual drain</td><td>M</td></tr> </table>	5µ Element	E	0.01µ Element	C	0.01µ Element with dpi	D	1µ Element	9	1µ Element with dpi	Q	Adsorber	A	Auto drain	A	Manual drain	M	<p>Relief / Adjustment</p> <table border="1"> <tr><td>Non-rising knob relieving</td><td>N</td></tr> </table> <p>Adjustment range</p> <table border="1"> <tr><td colspan="2">With round gauge</td></tr> <tr><td>2 bar; 30 psig; 0.2 MPa</td><td>Z</td></tr> <tr><td>4 bar; 60 psig; 0.4 MPa</td><td>M</td></tr> <tr><td>8 bar; 125 psig; 0.8 MPa</td><td>G</td></tr> <tr><td>17 bar; 250 psig; 1.7 MPa</td><td>J</td></tr> <tr><td colspan="2">Without gauge</td></tr> <tr><td>2 bar; 30 psig; 0.2 MPa</td><td>Y</td></tr> <tr><td>4 bar; 60 psig; 0.4 MPa</td><td>L</td></tr> <tr><td>8 bar; 125 psig; 0.8 MPa</td><td>N</td></tr> <tr><td>17 bar; 250 psig; 1.7 MPa</td><td>H</td></tr> </table>	Non-rising knob relieving	N	With round gauge		2 bar; 30 psig; 0.2 MPa	Z	4 bar; 60 psig; 0.4 MPa	M	8 bar; 125 psig; 0.8 MPa	G	17 bar; 250 psig; 1.7 MPa	J	Without gauge		2 bar; 30 psig; 0.2 MPa	Y	4 bar; 60 psig; 0.4 MPa	L	8 bar; 125 psig; 0.8 MPa	N	17 bar; 250 psig; 1.7 MPa	H	<p>Lub type</p> <table border="1"> <tr><td>Oil mist standard sight dome</td><td>L</td></tr> </table> <p>Drain type</p> <table border="1"> <tr><td>No drain; closed end</td><td>N</td></tr> </table>	Oil mist standard sight dome	L	No drain; closed end	N	<p>Mounting</p> <table border="1"> <tr><td>No bracket</td><td>A</td></tr> <tr><td>Port blocks</td><td>C</td></tr> <tr><td>Port blocks & wall brkt</td><td>D</td></tr> <tr><td>Wall bracket</td><td>W</td></tr> </table>	No bracket	A	Port blocks	C	Port blocks & wall brkt	D	Wall bracket	W
5µ Element	E																																																				
0.01µ Element	C																																																				
0.01µ Element with dpi	D																																																				
1µ Element	9																																																				
1µ Element with dpi	Q																																																				
Adsorber	A																																																				
Auto drain	A																																																				
Manual drain	M																																																				
Non-rising knob relieving	N																																																				
With round gauge																																																					
2 bar; 30 psig; 0.2 MPa	Z																																																				
4 bar; 60 psig; 0.4 MPa	M																																																				
8 bar; 125 psig; 0.8 MPa	G																																																				
17 bar; 250 psig; 1.7 MPa	J																																																				
Without gauge																																																					
2 bar; 30 psig; 0.2 MPa	Y																																																				
4 bar; 60 psig; 0.4 MPa	L																																																				
8 bar; 125 psig; 0.8 MPa	N																																																				
17 bar; 250 psig; 1.7 MPa	H																																																				
Oil mist standard sight dome	L																																																				
No drain; closed end	N																																																				
No bracket	A																																																				
Port blocks	C																																																				
Port blocks & wall brkt	D																																																				
Wall bracket	W																																																				

P 3 3

Combination	
B/V + Combination	Q
Combination + B/V	X
Combination	C
Shut off + Combination	Y
Combination + Shut off	Z

Combination type*	
F/R+L	A
F+R+L	B
F+Fc	F
F+Fc+Fa	G

* Combination type
 F = 5µ
 Fc1 = 1µ
 Fc = .01µ
 Fa = Adsorber

Thread type	
BSPP	1
BSPT	2
NPT	9

Port size	
1/2	4
3/4	6

Bowl type	
Poly bowl with bowl guard	G
Metal bowl without sight gauge	M
Metal bowl with sight gauge	S

Note: All bowl types are the same for each component
Example: If a "G" is specified for a F+L, both units would get a poly bowl with bowl guard.

Popular Combination Dimensions

P31C

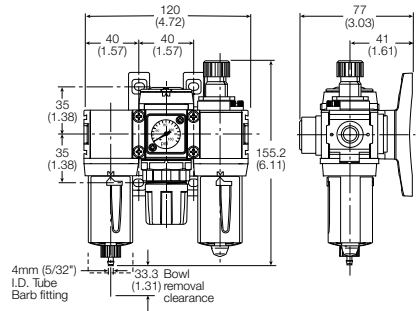
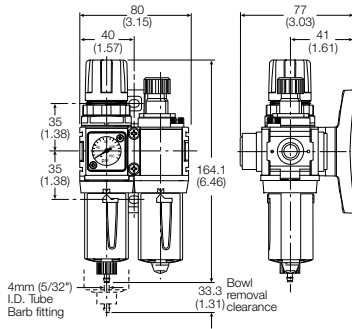

P32C

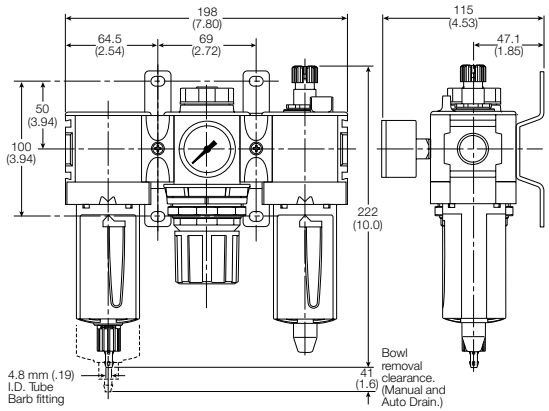
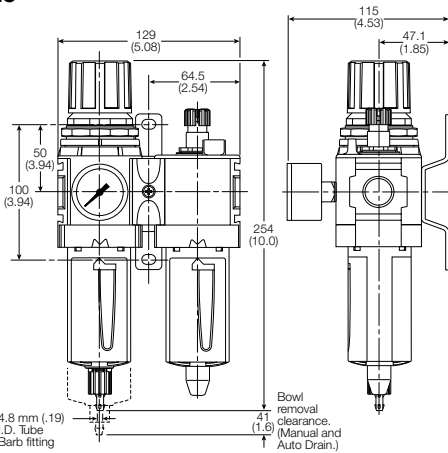

P33C

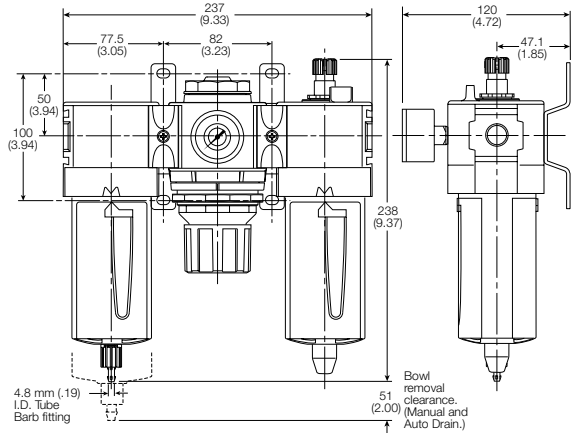
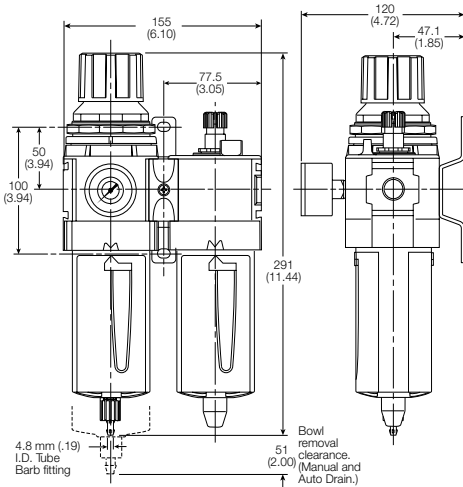

Mini Particulate Filter - P31



Symbols

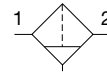

Manual drain

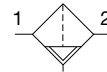

Auto drain

- Integral 1/4" ports (NPT, BSPP & BSPT)
- High efficiency 5 micron element as standard
- Excellent water removal efficiency
- Robust but lightweight aluminum construction
- One hand operation for easy element cartridge removal
- Positive bayonet latch to ensure correct & safe fitting

Options:

P 3 1	F A			E				N
Thread type		Port size		Bowl type		Mounting		
BSPP	1	1/8	1	Poly bowl with bowl guard	G	No bracket		
BSPT	2	1/4	2	Metal bowl without sight gauge	M			
NPT	9			Element		Drain type		
				5µ Element	E	Pulse drain	B	
						Manual drain	M	

Port size	Description	Order Code†	Flow dm ³ /s (scfm)	Max. bar (psig)	Height mm (inches)	Width mm (inches)	Depth mm (inches)
1/4"	Poly bowl - Manual drain	P31FA22EGMN	12 (25)	10 (150)	116.3 (4.58)	40 (1.58)	42.7 (1.68)
1/4"	Poly bowl - Pulse drain	P31FA22EGBN	12 (25)	10 (150)	116.3 (4.58)	40 (1.58)	42.7 (1.68)
1/4"	Metal bowl - Manual drain	P31FA22EMMN	12 (25)	17 (250)	116.3 (4.58)	40 (1.58)	42.7 (1.68)
1/4"	Metal bowl - Pulse drain	P31FA22EMBN	12 (25)	17 (250)	116.3 (4.58)	40 (1.58)	42.7 (1.68)

* flow with 6.3 bar (91.3 psig) inlet pressure and 0.34 (4.9 psig) pressure drop.

† **Standard part numbers shown in bold. For other models refer to Options chart above.**

Specifications

Flow Capacity*	1/4	12 dm ³ /s (25 scfm)
Max. Operating Temperature	Plastic Bowl	52°C (125°F)
	Metal Bowl	65.5°C (150°F)
Max. Supply Pressure	Plastic Bowl	10 bar (150 psig)
	Metal Bowl	17 bar (250 psig)
Standard Filtration		5 Micron
Useful Retention†		12 cm ³ (0.4 US oz.)
Port Size	BSPP / BSPT / NPT	1/8, 1/4

Weight 0.11 kg (0.24 lbs)
 * Inlet pressure 6.3 bar (91.3 psig). Pressure drop 0.34 bar (4.9 psig).
 † Useful retention refers to volume below the quiet zone baffle.

Air quality:

Within ISO 8573-1: 1991 Class 3 (Particulates)
 Within ISO 8573-1: 2001 Class 6 (Particulates)

Materials of Construction

Body	Aluminum
Body Cap	ABS
Bowl	Polycarbonate
Bowl Guard	Nylon
Element Retainer	Acetal
Baffle	Acetal
Filter Element	Sintered Polyethylene
Seals	Nitrile

Dimensions

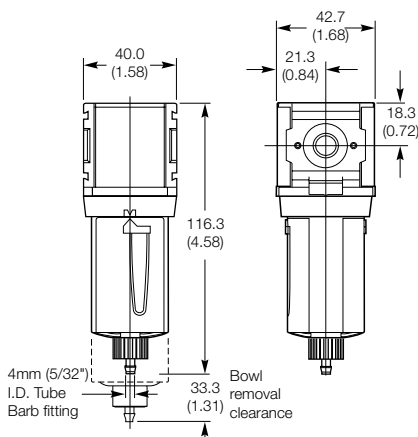

Flow Charts

1/4 Filter

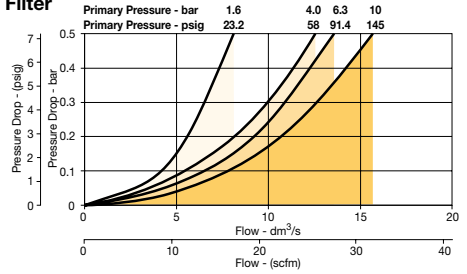

Repair and Service Kits

Plastic bowl / Bowl guard manual drain	P31KA00BGM
Metal bowl / w/o sight gauge manual drain	P31KA00BMM
Plastic bowl / Bowl guard pulse drain	P31KA00BGB
Metal bowl / w/o sight gauge pulse drain	P31KA00BMB
5µ particle filter element	P31KA00ESE
C-Bracket (fits to body)	P31KA00MW
T-Bracket with body connector	P31KA00MT
Body connector	P31KA00CB

Compact Particulate Filter - P32



Symbols

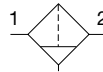

Manual drain

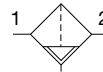

Auto drain

- Integral 1/4", 3/8" or 1/2" ports (NPT, BSPP & BSPT)
- High efficiency 5 micron element as standard
- Excellent water removal efficiency
- Robust but lightweight aluminum construction
- Positive bayonet latch to ensure correct & safe fitting

Options:

P 3 2	F A			E				N	
Thread type		Port size		Element		Bowl type		Drain type	
BSPP	1	1/4	2	5µ Element	E	Poly bowl with bowl guard	G	Mounting	
BSPT	2	3/8	3			Metal bowl without sight gauge	M	No bracket	
NPT	9	1/2	4			Metal bowl with sight gauge	S		
								Manual drain	
								Auto drain	
								M	
								A	

Port size	Description	Order Code†	Flow dm ³ /s (scfm)	Max. bar (psig)	Height mm (inches)	Width mm (inches)	Depth mm (inches)
1/4"	Poly bowl - Manual drain	P32FA22EGMN	18 (38)	10 (150)	188 (7.4)	60 (2.36)	60 (2.36)
1/4"	Poly bowl - Auto drain	P32FA22EGAN	18 (38)	10 (150)	182 (7.2)	60 (2.36)	60 (2.36)
1/4"	Metal bowl - Manual drain	P32FA22ESMN	18 (38)	17 (250)	188 (7.4)	60 (2.36)	60 (2.36)
1/4"	Metal bowl - Auto drain	P32FA22ESAN	18 (38)	17 (250)	182 (7.2)	60 (2.36)	60 (2.36)
3/8"	Poly bowl - Manual drain	P32FA23EGMN	30 (64)	10 (150)	188 (7.4)	60 (2.36)	60 (2.36)
3/8"	Poly bowl - Auto drain	P32FA23EGAN	30 (64)	10 (150)	182 (7.2)	60 (2.36)	60 (2.36)
3/8"	Metal bowl - Manual drain	P32FA23ESMN	30 (64)	17 (250)	188 (7.4)	60 (2.36)	60 (2.36)
3/8"	Metal bowl - Auto drain	P32FA23ESAN	30 (64)	17 (250)	182 (7.2)	60 (2.36)	60 (2.36)
1/2"	Poly bowl - Manual drain	P32FA24EGMN	38 (80)	10 (150)	188 (7.4)	60 (2.36)	60 (2.36)
1/2"	Poly bowl - Auto drain	P32FA24EGAN	38 (80)	10 (150)	182 (7.2)	60 (2.36)	60 (2.36)
1/2"	Metal bowl - Manual drain	P32FA24ESMN	38 (80)	17 (250)	188 (7.4)	60 (2.36)	60 (2.36)
1/2"	Metal bowl - Auto drain	P32FA24ESAN	38 (80)	17 (250)	182 (7.2)	60 (2.36)	60 (2.36)

* flow with 6.3 bar (91.3 psig) inlet pressure and 0.34 (4.9 psig) pressure drop.

† **Standard part numbers shown in bold. For other models refer to Options chart above.**

Specifications

Flow Capacity*	1/4	18 dm ³ /s (38 scfm)
	3/8	30 dm ³ /s (64 scfm)
	1/2	38 dm ³ /s (80 scfm)
Operating Temperature	Plastic Bowl	52°C (125°F)
	Metal Bowl	65.5°C (150°F)
Max. Supply Pressure	Plastic Bowl	10 bar (150 psig)
	Metal Bowl	17 bar (250 psig)
Standard Filtration	5 Micron	
Useful Retention†	51 cm ³ (1.7 US oz.)	
Port Size	BSPP / BSPT / NPT 1/4, 3/8, 1/2	
Weight	0.28 kg (0.62 lbs)	

* Inlet pressure 6.3 bar (91.3 psig). Pressure drop 0.34 bar (4.9 psig).
 † Useful retention refers to volume below the quiet zone baffle.

Air quality:

Within ISO 8573-1: 1991 Class 3 (Particulates)
 Within ISO 8573-1: 2001 Class 6 (Particulates)

Materials of Construction

Body	Aluminum	
Body Cap	ABS	
Bowls	Plastic Bowl	Polycarbonate
	Metal Bowl	Aluminum
Bowl Guard	Nylon	
Deflector	Polypropylene	
Element Retainer / Baffle	Acetal	
Filter Element	Sintered Polyethylene	
Seals	Plastic Bowl	Nitrile
	Metal Bowl	Nitrile
Sight Gauge	Metal Bowl	Polycarbonate

Dimensions

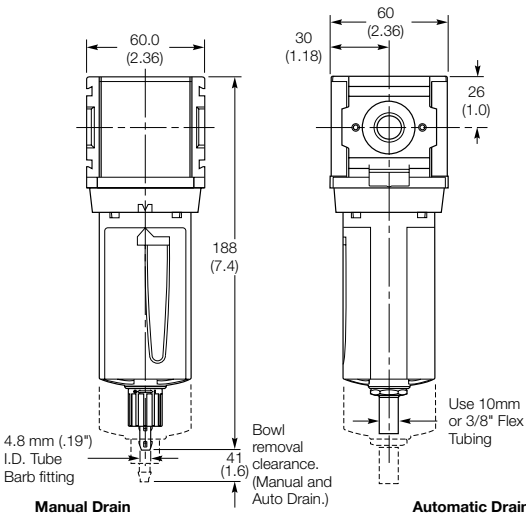

Flow Charts

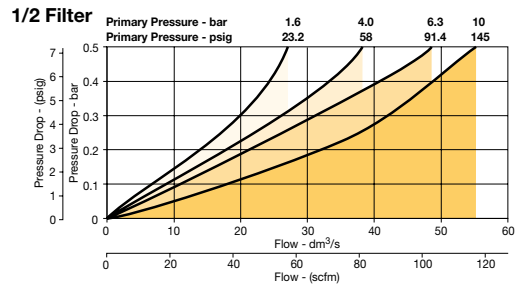
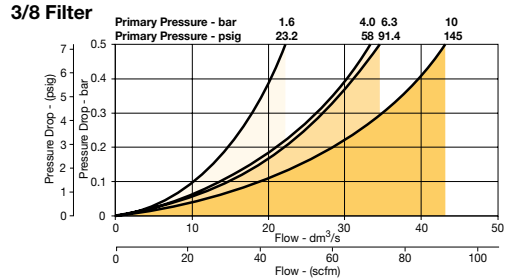
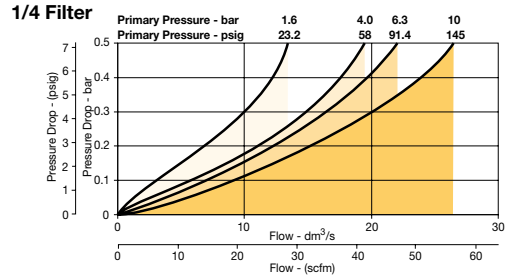

Repair and Service Kits

Plastic bowl / Bowl guard manual drain	P32KA00BGM
Metal bowl / Sight gauge manual drain	P32KA00BSM
Auto drain	P32KA00DA
5µ particle filter element	P32KA00ESE
L-Bracket (fits to body)	P32KA00ML
T-Bracket (fits to body connector)	P32KA00MB
T-Bracket with body connector	P32KA00MT
Body connector	P32KA00CB
Differential pressure indicator (replacement)	P32KA00RQ

Standard Particulate Filter - P33



Symbols

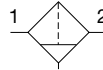

Manual drain

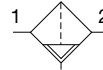

Auto drain

- Integral 1/2" or 3/4" ports (NPT, BSPP & BSPT)
- High efficiency 5 micron element as standard
- Excellent water removal efficiency
- Robust but lightweight aluminum construction
- Positive bayonet latch to ensure correct & safe fitting

Options:

P 3 3	F A			E				N
Thread type		Port size		Bowl type		Mounting		
BSPP	1	1/2	4	Poly bowl with bowl guard	G	No bracket		
BSPT	2	3/4	6	Metal bowl without sight gauge	M			
NPT	9			Metal bowl with sight gauge	S			
Element				Drain type				
5µ Element				Manual drain		M		
				Auto drain		A		

Port size	Description	Order Code†	Flow dm³/s (scfm)	Max. bar (psig)	Height mm (inches)	Width mm (inches)	Depth mm (inches)
1/2"	Poly bowl - Manual drain	P33FA24EGMN	40 (85)	10 (150)	213 (8.4)	73 (2.9)	73 (2.9)
1/2"	Poly bowl - Auto drain	P33FA24EGAN	40 (85)	10 (150)	207 (8.2)	73 (2.9)	73 (2.9)
1/2"	Metal bowl - Manual drain	P33FA24ESMN	40 (85)	17 (250)	213 (8.4)	73 (2.9)	73 (2.9)
1/2"	Metal bowl - Auto drain	P33FA24ESAN	40 (85)	17 (250)	207 (8.2)	73 (2.9)	73 (2.9)
3/4"	Poly bowl - Manual drain	P33FA26EGMN	48 (102)	10 (150)	213 (8.4)	73 (2.9)	73 (2.9)
3/4"	Poly bowl - Auto drain	P33FA26EGAN	48 (102)	10 (150)	207 (8.2)	73 (2.9)	73 (2.9)
3/4"	Metal bowl - Manual drain	P33FA26ESMN	48 (102)	17 (250)	213 (8.4)	73 (2.9)	73 (2.9)
3/4"	Metal bowl - Auto drain	P33FA26ESAN	48 (102)	17 (250)	207 (8.2)	73 (2.9)	73 (2.9)

* flow with 6.3 bar (91.3 psig) inlet pressure and 0.34 (4.9 psig) pressure drop.

† **Standard part numbers shown in bold. For other models refer to Options chart above.**

Specifications

Flow Capacity*	1/2	40 dm ³ /s (85 scfm)
	3/4	48 dm ³ /s (102 scfm)
Max. Operating Temperature	Plastic Bowl	52°C (125°F)
	Metal Bowl	65.5°C (150°F)
Max. Supply Pressure	Plastic Bowl	10 bar (150 psig)
	Metal Bowl	17 bar (250 psig)
Standard Filtration		5 Micron
Useful Retention†		85 cm ³ (2.8 US oz.)
Port Size	BSP / BSPT / NPT	1/2, 3/4
Weight		0.46 kg (1.01 lbs)

* Inlet pressure 6.3 bar (91.3 psig). Pressure drop 0.34 bar (4.9 psig).

† Useful retention refers to volume below the quiet zone baffle.

Air quality:

Within ISO 8573-1: 1991 Class 3 (Particulates)

Within ISO 8573-1: 2001 Class 6 (Particulates)

Materials of Construction

Body	Aluminum	
Body Cap	ABS	
Bowls	Plastic Bowl	Polycarbonate
	Metal Bowl	Aluminum
Bowl Guard	Nylon	
Deflector	Polypropylene	
Element Retainer / Baffle	Acetal	
Filter Element	Sintered Polyethylene	
Seals	Plastic Bowl	Nitrile
	Metal Bowl	Nitrile
Sight Gauge	Metal Bowl	Polycarbonate

Dimensions

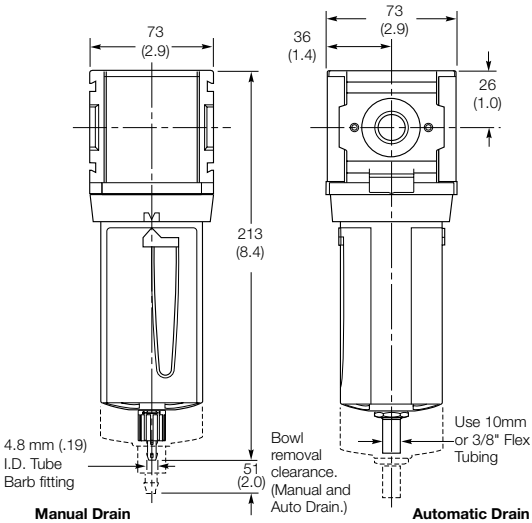

Flow Charts

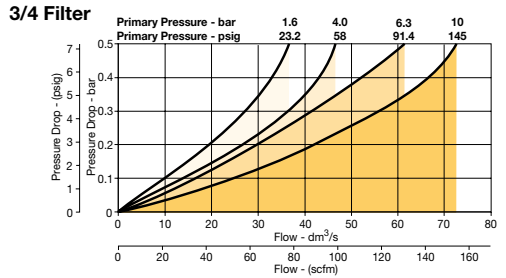
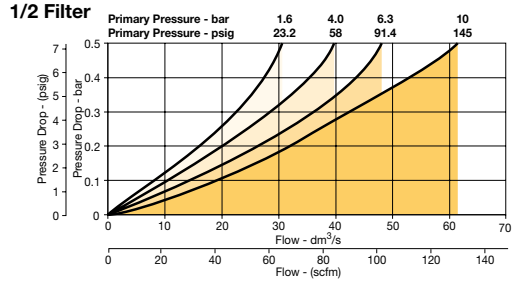

Repair and Service Kits

Plastic bowl / Bowl guard manual drain	P33KA00BGM
Metal bowl / Sight gauge manual drain	P33KA00BSM
Auto drain	P32KA00DA
5µ particle filter element	P33KA00ESE
L-Bracket (fits to body)	P33KA00ML
T-Bracket (fits to body connector)	P32KA00MB
T-Bracket with body connector	P33KA00MT
Body connector	P32KA00CB
Differential pressure indicator (replacement)	P32KA00RQ

Mini Coalescing and Adsorber Filters - P31



- Integral 1/4" ports (NPT, BSPP & BSPT)
- Removes liquid aerosols and sub micron particles
- Oil free air for critical applications, such as air gauging, pneumatic instrumentation and control
- Positive bayonet latch to ensure correct & safe fitting
- Adsorbing activated carbon element removes oil vapors and most hydrocarbons

Note: To optimize the life of coalescing element, it is advisable to install a P31F pre-filter with a 5 micron element upstream of the coalescing filter.

To optimize the life of an Adsorber it is advisable to install a P31 Coalescing Filter upstream of the Adsorber. Adsorber element should be replaced approximately every 1000 hours of service.

Options:

P 3 1	F A						N
Thread type		Port size		Bowl type		Mounting	
BSPP	1	1/8	1	Poly bowl with bowl guard	G	No bracket	N
BSPT	2	1/4	2	Metal bowl without sight gauge	M		
NPT	9						
Element				Drain type			
0.01µ Element		C		Pulse drain		B	
1µ Element		9		Manual drain		M	
Adsorber		A					

Port size	Description	Order Code†	Flow dm ³ /s (scfm)	Max. bar (psig)	Height mm (inches)	Width mm (inches)	Depth mm (inches)
1/4"	Poly bowl - 0.01 micron - Manual drain	P31FA22CGMN	2 (4.2)	10 (150)	116.3 (4.58)	40 (1.58)	42.7 (1.68)
1/4"	Poly bowl - 0.01 micron - Pulse drain	P31FA22CGBN	2 (4.2)	10 (150)	116.3 (4.58)	40 (1.58)	42.7 (1.68)
1/4"	Metal bowl - 0.01 micron - Manual drain	P31FA22CMMN	2 (4.2)	17 (250)	116.3 (4.58)	40 (1.58)	42.7 (1.68)
1/4"	Metal bowl - 0.01 micron - Pulse drain	P31FA22CMBN	2 (4.2)	17 (250)	116.3 (4.58)	40 (1.58)	42.7 (1.68)

* flow with 6.3 bar (91.3 psig) inlet pressure and 0.2 (3 psig) pressure drop.

† **Standard part numbers shown in bold. For other models refer to Options chart above.**

Indicates stocked product.

Specifications

Flow Capacity		dm ³ /s	SCFM
1.0 Micron Coalescing	Energy Efficient Flow*	3.8	(8)
	Maximum Flow**	6	(13)
Activated Carbon Adsorber	Rated Flow*	6	(13)
Max. Operating Temperature	Plastic Bowl	52°C	(125°F)
	Metal Bowl	65.5°C	(150°F)
Max. Supply Pressure	Plastic Bowl	10 bar	(150 psig)
	Metal Bowl	17 bar	(250 psig)
Standard Filtration		1.0 and 0.01 Micron	
		ppm wt	
Adsorber	Max. oil carryover (ppm w/w)	0.003 @ 21°C (70°F)	
Useful Retention†		12 cm ³ (0.4 US oz.)	
Port Size	BSPP / BSPT / NPT	1/4	
Weight		0.11 kg (0.24 lbs)	

* Inlet pressure 6.3 bar (91.3 psig), Pressure drop 0.2 bar (3 psig), Saturated Element.

** Inlet pressure 6.3 bar (91.3 psig), Pressure drop 0.4 bar (6 psig), Saturated Element.

† Useful retention refers to volume below the quiet zone baffle.

Materials of Construction

Body	Aluminum	
Body Cap	ABS	
Bowl	Plastic Bowl	Polycarbonate
	Metal Bowl	Aluminum
Filter Element	1.0 and .01 Micron	Borosilicate Cloth
Adsorber	Activated Carbon	
Seals	Nitrile	

Flow Charts

P31 - 1.0 micron flow

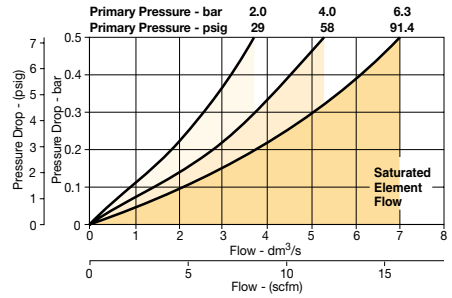

Dimensions

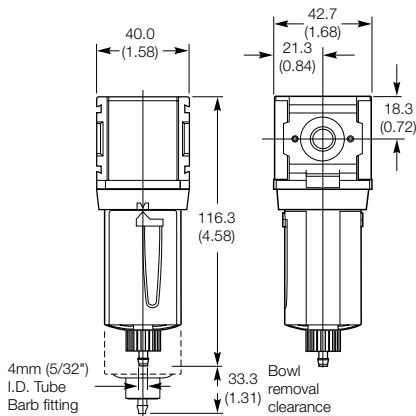

Repair and Service Kits

Plastic bowl / Bowl guard manual drain	P31KA00BGM
Metal bowl / w/o sight gauge manual drain	P31KA00BMM
Plastic bowl / Bowl guard pulse drain	P31KA00BGB
Metal bowl / w/o sight gauge pulse drain	P31KA00BMB
1µ coalescing filter element	P31KA00ES9
0.01µ coalescing filter element	P31KA00ESC
Activated carbon adsorber filter element	P31KA00ESA
C-Bracket (fits to body)	P31KA00MW
T-Bracket with body connector	P31KA00MT
Body connector	P31KA00CB

Compact Coalescing and Adsorber Filter - P32



- Integral 1/4", 3/8" or 1/2" ports (NPT, BSPP & BSPT)
- Removes liquid aerosols and sub micron particles
- Oil free air for critical applications, such as air gauging, pneumatic instrumentation and control
- Differential Pressure Indicator (DPI) standard on Coalescing Filters
- Positive bayonet latch to ensure correct & safe fitting
- Adsorbing activated carbon element removes oil vapors and most hydrocarbons

Note: To optimize the life of coalescing element, it is advisable to install a P32F pre-filter with a 5 micron element upstream of the coalescing filter.

To optimize the life of an Adsorber it is advisable to install a P32 Coalescing Filter upstream of the Adsorber. Adsorber element should be replaced approximately every 1000 hours of service.

Options:

P 3 2	F A							N
Thread type		Port size		Bowl type			Mounting	
BSPP	1	1/4	2	Poly bowl with bowl guard	G		No bracket	N
BSPT	2	3/8	3	Metal bowl without sight gauge	M			
NPT	9	1/2	4	Metal bowl with sight gauge	S			
Element				Drain type				
0.01µ Element		C		Manual drain	M			
0.01µ Element with dpi		D		Auto drain	A			
1µ Element		9						
1µ Element with dpi		Q						
Adsorber		A						

Port size	Description	Order Code†	Flow dm ³ /s (scfm)	Max. bar (psig)	Height mm (inches)	Width mm (inches)	Depth mm (inches)
1/4"	Poly bowl - 0.01 Micron, Manual drain	P32FA22DGMN	11 (23)	10 (150)	209 (8.2)	60 (2.36)	60 (2.36)
1/4"	Poly bowl - 0.01 Micron, Auto drain	P32FA22DGAN	11 (23)	10 (150)	203 (8.0)	60 (2.36)	60 (2.36)
1/4"	Metal bowl - 0.01 Micron, Manual drain	P32FA22DSMN	11 (23)	17 (250)	209 (8.2)	60 (2.36)	60 (2.36)
1/4"	Metal bowl - 0.01 Micron, Auto drain	P32FA22DSAN	11 (23)	17 (250)	203 (8.0)	60 (2.36)	60 (2.36)
3/8"	Poly bowl - 0.01 Micron, Manual drain	P32FA23DGMN	11 (23)	10 (150)	209 (8.2)	60 (2.36)	60 (2.36)
3/8"	Poly bowl - 0.01 Micron, Auto drain	P32FA23DGAN	11 (23)	10 (150)	203 (8.0)	60 (2.36)	60 (2.36)
3/8"	Metal bowl - 0.01 Micron, Manual drain	P32FA23DSMN	11 (23)	17 (250)	209 (8.2)	60 (2.36)	60 (2.36)
3/8"	Metal bowl - 0.01 Micron, Auto drain	P32FA23DSAN	11 (23)	17 (250)	203 (8.0)	60 (2.36)	60 (2.36)
1/2"	Poly bowl - 0.01 Micron, Manual drain	P32FA24DGMN	11 (23)	10 (150)	209 (8.2)	60 (2.36)	60 (2.36)
1/2"	Poly bowl - 0.01 Micron, Auto drain	P32FA24DGAN	11 (23)	10 (150)	203 (8.0)	60 (2.36)	60 (2.36)
1/2"	Metal bowl - 0.01 Micron, Manual drain	P32FA24DSMN	11 (23)	17 (250)	209 (8.2)	60 (2.36)	60 (2.36)
1/2"	Metal bowl - 0.01 Micron, Auto drain	P32FA24DSAN	11 (23)	17 (250)	203 (8.0)	60 (2.36)	60 (2.36)

* flow with 6.3 bar (91.3 psig) inlet pressure and 0.2 (3 psig) pressure drop.

† **Standard part numbers shown in bold. For other models refer to Options chart above.**

Specifications

Flow Capacity		dm ³ /s	SCFM
1.0 Micron Coalescing	Energy Efficient Flow*	17	(36)
	Maximum Flow**	27	(57)
0.01 Micron Coalescing	Energy Efficient Flow*	11	(23)
	Maximum Flow**	28	(38)
Activated Carbon Adsorber	Rated Flow*	27	(57)
Max. Operating Temperature	Plastic Bowl	52°C (125°F)	
	Metal Bowl	65.5°C (150°F)	
Max. Supply Pressure	Plastic Bowl	10 bar (150 psig)	
	Metal Bowl	17 bar (250 psig)	
Standard Filtration		1.0 and 0.01 Micron	
		ppm wt	
Adsorber	Max. oil carryover (ppm w/w)	0.003 @ 21°C (70°F)	
Useful Retention†		51 cm ³ (1.7 US oz.)	
Port Size	BSP / BSPT / NPT	1/4, 3/8, 1/2	
Weight		0.32 kg (0.71 lbs)	

* Inlet pressure 6.3 bar (91.3 psig), Pressure drop 0.2 bar (3 psig), Saturated Element.

** Inlet pressure 6.3 bar (91.3 psig), Pressure drop 0.4 bar (6 psig), Saturated Element.

† Useful retention refers to volume below the quiet zone baffle.

Dimensions

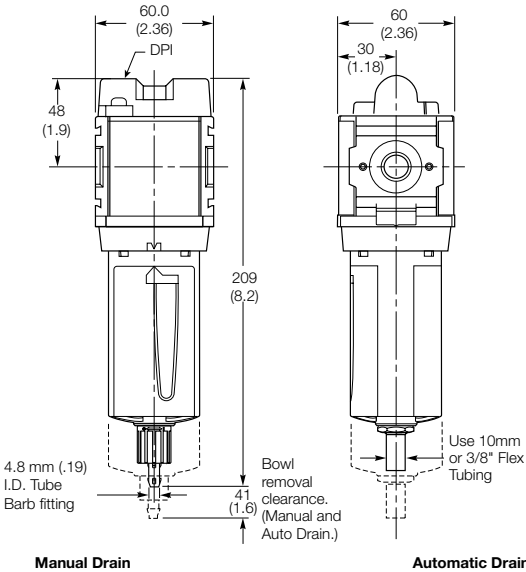

Flow Charts

P32 - 1.0 micron flow

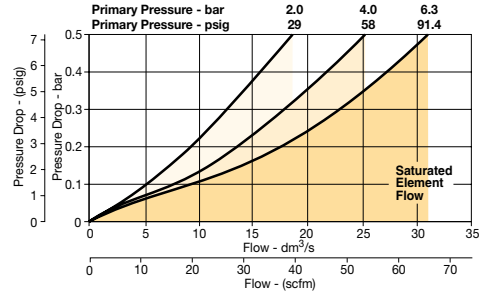

P32 - 0.01 micron flow

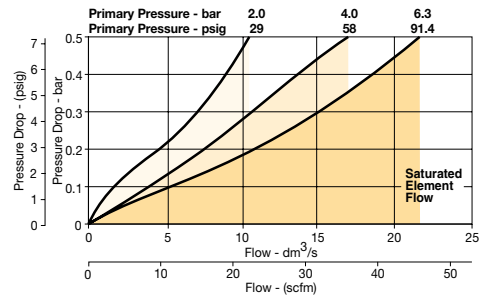

Materials of Construction

Body	Aluminum	
Body Cap	ABS	
Bowls	Plastic Bowl	Polycarbonate
	Metal Bowl	Aluminum
Filter Element	1.0 and .01 Micron	Borosilicate Cloth
Adsorber	Activated Carbon	
Seals	Nitrile	
Sight Gauge	Metal Bowl	Polycarbonate

Repair and Service Kits

Plastic bowl / Bowl guard manual drain	P32KA00BGM
Metal bowl / Sight gauge manual drain	P32KA00BSM
Auto drain	P32KA00DA
1µ coalescing filter element	P32KA00ES9
0.01µ coalescing filter element	P32KA00ESC
Activated carbon adsorber filter element	P32KA00ESA
L-Bracket (fits to body)	P32KA00ML
T-Bracket (fits to body connector)	P32KA00MB
T-Bracket with body connector	P32KA00MT
Body connector	P32KA00CB
Differential pressure indicator (replacement)	P32KA00RQ

Standard Coalescing and Adsorber Filter - P33



- Integral 1/2" or 3/4" ports (NPT, BSPP & BSPT)
- Removes liquid aerosols and sub micron particles
- Oil free air for critical applications, such as air gauging, pneumatic instrumentation and control
- Differential Pressure Indicator (DPI) standard on Coalescing Filters
- Positive bayonet latch to ensure correct & safe fitting
- Adsorbing activated carbon element removes oil vapors and most hydrocarbons

Note: To optimize the life of coalescing element, it is advisable to install a P33F pre-filter with a 5 micron element upstream of the coalescing filter.

To optimize the life of an Adsorber it is advisable to install a P33 Coalescing Filter upstream of the Adsorber. Adsorber element should be replaced approximately every 1000 hours of service.

Options:

P 3 3	F A						N
Thread type		Port size		Bowl type		Mounting	
BSPP	1	1/2	4	Poly bowl with bowl guard	G	No bracket	N
BSPT	2	3/4	6	Metal bowl without sight gauge	M		
NPT	9			Metal bowl with sight gauge	S		
Element				Drain type			
0.01µ Element	C	Manual drain	M	0.01µ Element with dpi	D	Auto drain	A
1µ Element	9			1µ Element with dpi	Q		
Adsorber	A						

Port size	Description	Order Code†	Flow dm ³ /s (scfm)	Max. bar (psig)	Height mm (inches)	Width mm (inches)	Depth mm (inches)
1/2"	Poly bowl - 0.01 Micron, Manual drain	P33FA24DGMN	20 (42)	10 (150)	235 (9.3)	73 (2.9)	73 (2.9)
1/2"	Poly bowl - 0.01 Micron, Auto drain	P33FA24DGAN	20 (42)	10 (150)	229 (9.0)	73 (2.9)	73 (2.9)
1/2"	Metal bowl - 0.01 Micron, Manual drain	P33FA24DSMN	20 (42)	17 (250)	235 (9.3)	73 (2.9)	73 (2.9)
1/2"	Metal bowl - 0.01 Micron, Auto drain	P33FA24DSAN	20 (42)	17 (250)	229 (9.0)	73 (2.9)	73 (2.9)
3/4"	Poly bowl - 0.01 Micron, Manual drain	P33FA26DGMN	20 (42)	10 (150)	235 (9.3)	73 (2.9)	73 (2.9)
3/4"	Poly bowl - 0.01 Micron, Auto drain	P33FA26DGAN	20 (42)	10 (150)	229 (9.0)	73 (2.9)	73 (2.9)
3/4"	Metal bowl - 0.01 Micron, Manual drain	P33FA26DSMN	20 (42)	17 (250)	235 (9.3)	73 (2.9)	73 (2.9)
3/4"	Metal bowl - 0.01 Micron, Auto drain	P33FA26DSAN	20 (42)	17 (250)	229 (9.0)	73 (2.9)	73 (2.9)

* flow with 6.3 bar (91.3 psig) inlet pressure and 0.2 (3 psig) pressure drop.

† Standard part numbers shown in bold. For other models refer to Options chart above.

Specifications

Flow Capacity		dm ³ /s	SCFM
1.0 Micron Coalescing	Energy Efficient Flow*	32	(68)
	Maximum Flow**	44	(93)
0.01 Micron Coalescing	Energy Efficient Flow*	20	(42)
	Maximum Flow**	34	(72)
Activated Carbon Adsorber	Rated Flow*	44	(93)
Max. Operating Temperature	Plastic Bowl	52°C (125°F)	
	Metal Bowl	65.5°C (150°F)	
Max. Supply Pressure	Plastic Bowl	10 bar (150 psig)	
	Metal Bowl	17 bar (250 psig)	
Standard Filtration		1.0 and 0.01 Micron ppm wt	

Adsorber	Max. oil carryover (ppm w/w)	0.003 @ 21°C (70°F)
Useful Retention†		85 cm ³ (2.8 US oz.)
Port Size	BSPB / BSPT / NPT	1/2, 3/4
Weight		0.50 kg (1.10 lbs)

* Inlet pressure 6.3 bar (91.3 psig), Pressure drop 0.2 bar (3 psig), Saturated Element.

** Inlet pressure 6.3 bar (91.3 psig), Pressure drop 0.4 bar (6 psig), Saturated Element.

† Useful retention refers to volume below the quiet zone baffle.

Dimensions

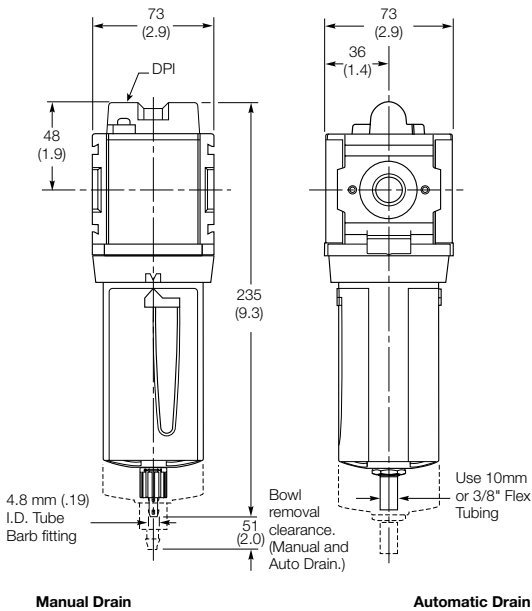

Flow Charts

P33 - 1.0 micron flow

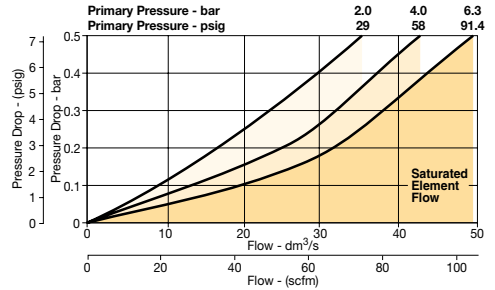

P33 - 0.01 micron flow

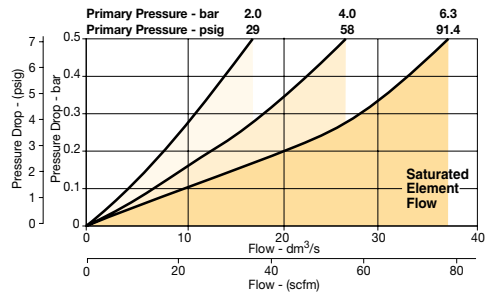

Materials of Construction

Body	Aluminum
Body Cap	ABS
Bowls	Plastic Bowl: Polycarbonate Metal Bowl: Zinc
Filter Element	1.0 and .01 Micron: Borosilicate Cloth
Adsorber	Activated Carbon
Seals	Nitrile
Sight Gauge	Metal Bowl: Polycarbonate

Repair and Service Kits

Plastic bowl / Bowl guard manual drain	P33KA00BGM
Metal bowl / Sight gauge manual drain	P33KA00BSM
Auto drain	P32KA00DA
1µ coalescing filter element	P33KA00ES9
0.01µ coalescing filter element	P33KA00ESC
Activated carbon adsorber filter element	P33KA00ESA
L-Bracket (fits to body)	P33KA00ML
T-Bracket (fits to body connector)	P32KA00MB
T-Bracket with body connector	P32KA00MT
Body connector	P32KA00CB
Differential pressure indicator (replacement)	P32KA00RQ

Mini Regulator - P31



Symbols

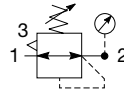

Self relieving regulator with gauge

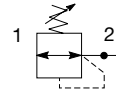

Non relieving regulator with gauge

- Integral 1/4" ports (NPT, BSPP & BSPT)
- Robust but lightweight aluminum construction
- Secondary pressure ranges 0-2 bar (0-30 psig), 0-4 bar, (0-60 psig), 0-8 bar (0-125 psig)
- Secondary aspiration plus balanced poppet provides quick response and accurate pressure regulation.
- Relieving & Non-relieving types
- Non-rising knob

Options:

P 31	RA				N		P
Thread type		Port size		Mounting			
BSPP	1	1/4	2	Plastic panel mount nut		P	
BSPT	2						
NPT	9						
		Relief		Adjustment range			
		Relieving	B	With square gauge	With round gauge	Without gauge	
		Non relieving	N	2 bar (0.2 MPa)*	2 2 bar (0.2 MPa)	Z	2 bar (0.2 MPa) Y
		Reverse flow / relieving	R	4 bar (0.4 MPa)*	4 4 bar (0.4 MPa)	M	4 bar (0.4 MPa) L
				8 bar (0.8 MPa)**	6 8 bar (0.8 MPa)	G	8 bar (0.8 MPa) N

Port size	Description	Order Code†	Flow dm ³ /s (scfm)	Max. bar (psig)	Height mm (inches)	Width mm (inches)	Depth mm (inches)
1/4"	8 bar (125 psig) relieving	P31RA22BNNP	30 (64)	20 (300)	100.1 (3.94)	40 (1.58)	40 (1.58)
1/4"	8 bar (125 psig) + gauge	P31RA22BN6P	30 (64)	20 (300)	100.1 (3.94)	40 (1.58)	64.3 (2.53)

* flow with 10 bar (145 psig) inlet pressure, 6.3 bar (91.3 psig) set pressure and 1 bar (14.5 psig) pressure drop.

† **Standard part numbers shown in bold. For other models refer to Options chart above.**

Specifications

Flow Capacity*	1/4	30 dm ³ /s (64 scfm)
Max. Operating Temperature		65.5°C (150°F)
Max. Supply Pressure		20 bar (300 psig)
Adjusting Range Pressure		0-2 bar (30 psig) 0-4 bar (60 psig) 0-8 bar (125 psig)
Port Size	BSPP / BSPT / NPT	1/4
Gauge Port (2 ea.)**	BSPP / BSPT / NPT	1/8
Weight		0.17 kg (0.37 lbs)

* Inlet pressure 10 bar (145 psig). Secondary pressure 6.3 bar (91.3 psig).

** Non-gauge option only.

Materials of Construction

Body	Aluminum
Adjustment Knob	Acetal
Body Cap	ABS
Bonnet	PBT
Diaphragm Assembly	Brass / Nitrile
Bottom Plug	33% Glass-Filled Nylon
Valve Assembly	Brass / Nitrile
Springs	Steel
Seals	Nitrile
Panel Nut	Acetal

Dimensions

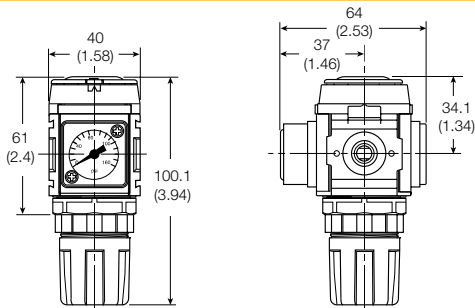

NOTE: 31.7 mm (1.25 in.) hole required for panel nut mounting.



WARNING

**Product rupture can cause serious injury.
Do not connect regulator to bottled gas.
Do not exceed Maximum primary pressure rating.**

CAUTION:

REGULATOR PRESSURE ADJUSTMENT – The working range of knob adjustment is designed to permit outlet pressures within their full range. Pressure adjustment beyond this range is also possible because the knob is not a limiting device. This is a common characteristic of most industrial regulators, and limiting devices may be obtained only by special design. For best performance, regulated pressure should always be set by increasing the pressure up to the desired setting.

Flow Charts

1/4 Regulator

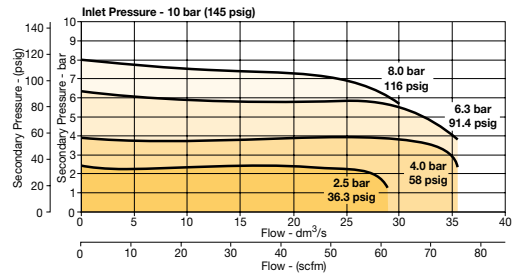

Repair and Service Kits

Regulator repair kit - Relieving	P31KA00RB
Regulator repair kit - Non-relieving	P31KA00RC
Panel mount nut - Aluminum	P31KA00MM
Panel mount nut - Plastic	P31KA00MP
Angle Bracket (uses panel mount threads)	P31KA00MR
C-Bracket (fits to body)	P31KA00MW
T-Bracket with body connector	P31KA00MT
Body connector	P31KA00CB

Gauges

Square flush mount gauge

0-4 bar	K4511SCR04B
0-10 bar	K4511SCR11B
0-60 psig	K4511SCR060
0-150 psig	K4511SCR150
0-0.4 Mpa	K45SCR04M
0-1.1 Mpa	K45SCR11M

40mm Round 1/8" center back mount

(Not for use with Common Port Regulators)

0-2 bar (0-0.2 Mpa)	K4515R1402B
0-4 bar (0-0.4 Mpa)	K4515R1404B
0-8 bar (0-0.8 Mpa)	K4515R1411B

For best performance, regulated pressure should always be set by increasing the pressure up to the desired setting.

Mini Common - P1 Regulator - P31

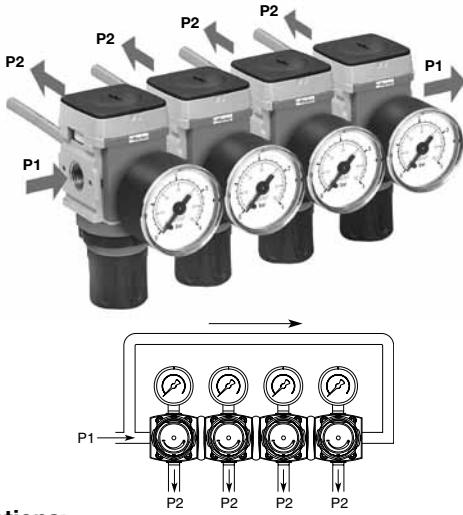

Symbols

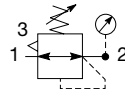

Self relieving regulator with gauge

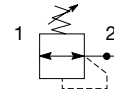

Non relieving regulator

- Manifold style regulator with line pressure on both sides.
- Pressure output is at front or rear.
- Integral 1/4" ports (NPT, BSPP & BSPT)
- Robust construction
- Secondary pressure ranges 0-2 bar (0-30 psig), 0-4 bar, (0-60 psig), 0-8 bar (0-125 psig)
- Secondary aspiration plus balanced poppet provides quick response and accurate pressure regulation
- Relieving & Non-relieving types
- Non-rising knob

Options:

P 3 1	H A			N		P
Thread type		Port size		Relief		Mounting
BSPP	1	1/4	2	Relieving	B	Plastic panel mount nut P
BSPT	2			Non relieving	N	
NPT	9			Adjustment range		
				Without gauge		
				2 bar; 30 psig	Y	
				4 bar; 60 psig	L	
				8 bar; 125 ps	N	

Order gauges separately - see next page.

Port size	Description	Order Code†	Flow dm ³ /s (scfm)	Max. bar (psig)	Height mm (inches)	Width mm (inches)	Depth mm (inches)
1/4"	8 bar (125 psig) Relieving	P31HA22BNNP	18 (38)	20 (300)	100.1 (3.94)	40 (1.58)	40 (1.58)

* flow with 10 bar (145 psig) inlet pressure, 6.3 bar (91.3) psig set pressure and 1 bar (14.5 psig) pressure drop.

† **Standard part numbers shown in bold. For other models refer to Options chart above.**

Specifications

Flow Capacity*	1/4	18 dm ³ /s (38 scfm)
Max. Operating Temperature		65.5°C (150°F)
Max. Supply Pressure		20 bar (300 psig)
Adjusting Range Pressure		0-2 bar (30 psig)
		0-4 bar (60 psig)
		0-8 bar (125 psig)
P1 Port Size (Inlet / Outlet)	BSP / BSPT / NPT	1/4
P2 Regulated Ports (2 ea.)	BSP / BSPT / NPT	1/8
Weight		0.30 kg (0.66 lbs)

* Inlet pressure 10 bar (145 psig), Secondary pressure 6.3 bar (91.3) psig.

Materials of Construction

Body	Zinc
Adjustment Knob	Acetal
Body Cap	ABS
Bonnet	33% Glass-filled PBT
Diaphragm Assembly	Brass / Nitrile
Bottom Plug	33% Glass-filled Nylon
Valve Assembly	Brass / Nitrile

Dimensions

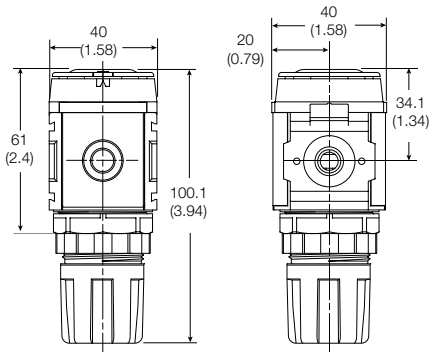

NOTE: 31.7 mm (1.25 in.) hole required for panel nut mounting.

⚠ WARNING

**Product rupture can cause serious injury.
Do not connect regulator to bottled gas.
Do not exceed Maximum primary pressure rating.**

CAUTION:

REGULATOR PRESSURE ADJUSTMENT – The working range of knob adjustment is designed to permit outlet pressures within their full range. Pressure adjustment beyond this range is also possible because the knob is not a limiting device. This is a common characteristic of most industrial regulators, and limiting devices may be obtained only by special design. For best performance, regulated pressure should always be set by increasing the pressure up to the desired setting.

Flow Charts

1/4 Common Regulator

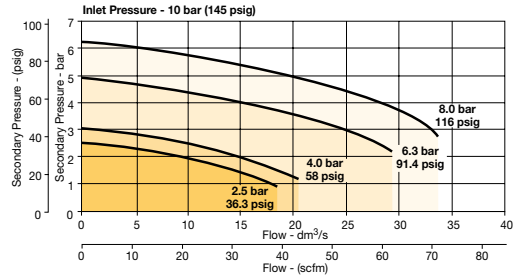

Repair and Service Kits

Regulator repair kit - Relieving	P31KA00RB
Regulator repair kit - Non-relieving	P31KA00RC
Panel mount nut - Aluminum	P31KA00MM
Panel mount nut - Plastic	P31KA00MP
Angle Bracket (uses panel mount threads)	P31KA00MR
T-Bracket with body connector	P31KA00MT
Body connector	P31KA00CB

Gauges

1.25" Round 1/8" center back mount	
0-60 psig / 0-4 bar	K4513N18060
0-160 psig / 0-11 bar	K4513N18160

For best performance, regulated pressure should always be set by increasing the pressure up to the desired setting.

Compact Regulator – P32



Symbols

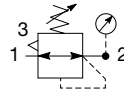

Self relieving regulator with gauge

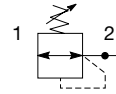

Non relieving regulator

- Integral 1/4", 3/8" or 1/2" ports (NPT, BSPP & BSPT)
- Robust but lightweight aluminum construction
- Secondary pressure ranges 0-2 bar (0-30 psig), 0-4 bar, (0-60 psig), 0-8 bar (0-125 psig), 0-17 bar (0-250 psig)
- Secondary aspiration plus balanced poppet provides quick response and accurate pressure regulation
- Relieving & Non-relieving types
- Non-rising knob

Options:

P 3 2	RA				N		P
Thread type		Port size		Mounting			
BSPP	1	1/4	2	Plastic panel mount nut		P	
BSPT	2	3/8	3				
NPT	9	1/2	4				
		Relief		Adjustment range			
		Relieving		With round gauge			
		Non relieving		2 bar; 30 psig; 0.2 MPa		Z	
		Reverse flow / relieving		4 bar; 60 psig; 0.4 MPa		M	
				8 bar; 125 psig; 0.8 MPa		G	
				17 bar; 250 psig; 1.7 MPa		J	
				Without gauge			
				2 bar; 30 psig; 0.2 MPa		Y	
				4 bar; 60 psig; 0.4 MPa		L	
				8 bar; 125 psig; 0.8 MPa		N	
				17 bar; 250 psig; 1.7 MPa		H	

Port size	Description	Order Code†	Flow dm ³ /s (scfm)	Max. bar (psig)	Height mm (inches)	Width mm (inches)	Depth mm (inches)
1/4"	8 bar (125 psig) Relieving	P32RA22BNNP	41 (81)	20 (300)	136 (5.4)	60 (2.36)	60 (2.36)
1/4"	8 bar (125 psig) Relieving + Gauge	P32RA22BNGP	41 (81)	20 (300)	136 (5.4)	60 (2.36)	60 (2.36)
3/8"	8 bar (125 psig) Relieving	P32RA23BNNP	65 (138)	20 (300)	136 (5.4)	60 (2.36)	60 (2.36)
3/8"	8 bar (125 psig) Relieving + Gauge	P32RA23BNGP	65 (138)	20 (300)	136 (5.4)	60 (2.36)	60 (2.36)
1/2"	8 bar (125 psig) Relieving	P32RA24BNNP	67 (142)	20 (300)	136 (5.4)	60 (2.36)	60 (2.36)
1/2"	8 bar (125 psig) Relieving + Gauge	P32RA24BNGP	67 (142)	20 (300)	136 (5.4)	60 (2.36)	60 (2.36)

* flow with 10 bar (145 psig) inlet pressure, 6.3 bar (91.3 psig) set pressure and 1 bar (14.5 psig) pressure drop.

† Standard part numbers shown in bold. For other models refer to Options chart above.

Specifications

Flow Capacity*	1/4	41 dm³/s (81 scfm)
	3/8	65 dm³/s (138 scfm)
	1/2	67 dm³/s (142 scfm)
Max. Operating Temperature	65.5°C (150°F)	
Max. Supply Pressure	20 bar (300 psig)	
Adjusting Range Pressure	0-2 bar (30 psig)	
	0-4 bar (60 psig)	
	0-8 bar (125 psig)	
	0-17 bar (250 psig)	
Port Size	BSP / BSPT / NPT	1/4, 3/8, 1/2
Gauge Port (2 ea.)	BSP / BSPT / NPT	1/4
Weight	0.41 kg (0.90 lbs)	

* Inlet pressure 10 bar (145 psig). Secondary pressure 6.3 bar (91.3) psig.

Materials of Construction

Body	Aluminum	
Adjustment Knob	Acetal	
Body Cap	ABS	
Bonnet	33% Glass-filled nylon	
Diaphragm Assembly	Nitrile / Zinc	
Bottom Plug	33% Glass-filled Nylon	
Valve Assembly	Brass / Nitrile	
Springs	Main Regulating Valve	Steel S.S.
Seals	Nitrile	
Panel Nut	Acetal	

Dimensions

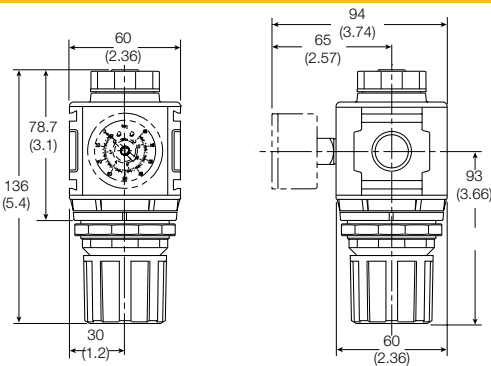

NOTE: 51 mm (2.00 in.) hole required for panel nut mounting.

⚠ WARNING

**Product rupture can cause serious injury.
Do not connect regulator to bottled gas.
Do not exceed Maximum primary pressure rating.**

CAUTION:

REGULATOR PRESSURE ADJUSTMENT – The working range of knob adjustment is designed to permit outlet pressures within their full range. Pressure adjustment beyond this range is also possible because the knob is not a limiting device. This is a common characteristic of most industrial regulators, and limiting devices may be obtained only by special design. For best performance, regulated pressure should always be set by increasing the pressure up to the desired setting.

Flow Charts

1/4 Regulator

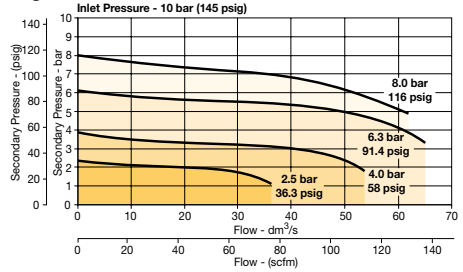

3/8 Regulator

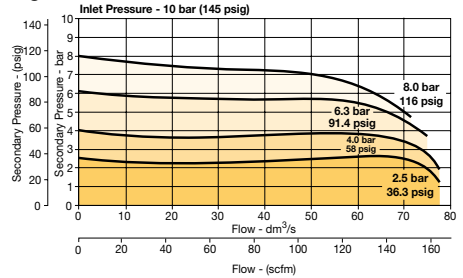

1/2 Regulator

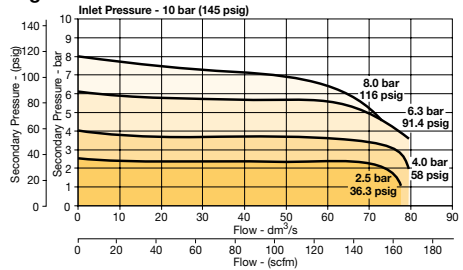

Repair and Service Kits

Regulator repair kit - Relieving	P32KA00RB
Regulator repair kit - Non-relieving	P32KA00RC
Panel mount nut - Aluminum	P32KA00MM
Panel mount nut - Plastic	P32KA00MP
Angle Bracket (uses panel mount threads)	P32KA00MR
T-Bracket with body connector	P32KA00MT
T-Bracket	P32KA00MB
Body connector	P32KA00CB

Gauges

50mm (2") Round 1/4" center back mount

0-2 bar / 0-0.2 Mpa / 0-30 psig	K4520R1402B
0-4 bar / 0-0.4 Mpa / 0-60 psig	K4520R1404B
0-11 bar / 0-1.1 Mpa / 0-160 psig	K4520R1411B
0-20 bar / 0-2 Mpa / 0-300 psig	K4520R1420B

For best performance, regulated pressure should always be set by increasing the pressure up to the desired setting.



Compact Common P1 Regulator - P32

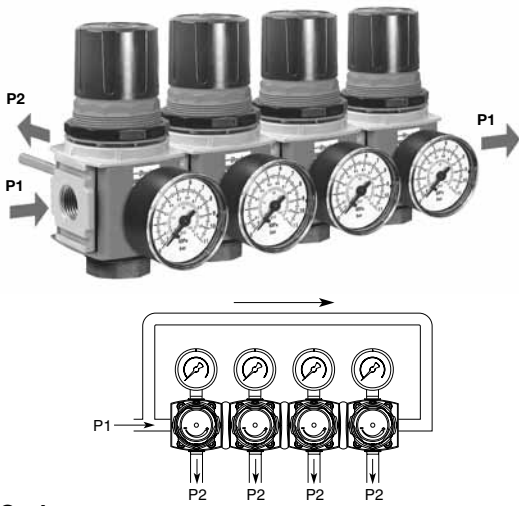

Symbols

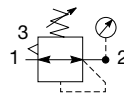

Self relieving regulator with gauge

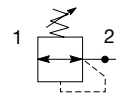

Non relieving regulator with gauge

- Manifold style regulator with line pressure on both sides.
- Pressure output is at front or rear.
- Integral 1/4", 3/8" or 1/2" ports (NPT, BSPP & BSPT)
- Robust construction
- Secondary pressure ranges 0-2 bar (0-30 psig), 0-4 bar, (0-60 psig), 0-8 bar (0-125 psig), 0-17 bar (0-250 psig)
- Secondary aspiration plus balanced poppet provides quick response and accurate pressure regulation
- Relieving & Non-relieving types
- Non-rising knob

Options:

P 3 2	HA				N		P
Thread type		Port size		Mounting			
BSPP	1	1/4	2	Plastic panel mount nut P			
BSPT	2	3/8	3				
NPT	9	1/2	4				
		Relief		Adjustment range			
		Relieving		Without gauge			
		Non relieving		2 bar; 30 psig; 0.2 MPa Y			
		B		4 bar; 60 psig; 0.4 MPa L			
		N		8 bar; 125 psig; 0.8 MPa N			
				17 bar; 250 psig; 1.7 MPa H			

Order gauges separately- see next page.

Port size	Description	Order Code†	Flow dm ³ /s (scfm)	Max. bar (psig)	Height mm (inches)	Width mm (inches)	Depth mm (inches)
1/4"	8 bar (125 psig) Relieving	P32HA22BNNP	28 (59)	20 (300)	136 (5.4)	60 (2.36)	60 (2.36)
3/8"	8 bar (125 psig) Relieving	P32HA23BNNP	28 (59)	20 (300)	136 (5.4)	60 (2.36)	60 (2.36)
1/2"	8 bar (125 psig) Relieving	P32HA24BNNP	28 (59)	20 (300)	136 (5.4)	60 (2.36)	60 (2.36)

* flow with 10 bar (145 psig) inlet pressure, 6.3 bar (91.3 psig) set pressure and 1 bar (14.5 psig) pressure drop.

† **Standard part numbers shown in bold. For other models refer to Options chart above.**

Specifications

Flow Capacity*	1/4	28 dm ³ /s (59 scfm)
	3/8	28 dm ³ /s (59 scfm)
	1/2	28 dm ³ /s (59 scfm)
Max. Operating Temperature	65.5°C (150°F)	
Max. Supply Pressure	20 bar (300 psig)	
Adjusting Range Pressure	0-2 bar (30 psig)	
	0-4 bar (60 psig)	
	0-8 bar (125 psig)	
	0-17 bar (250 psig)	
Port Size	BSPP / BSPT / NPT 1/4, 3/8, 1/2	
Gauge Port (2 ea.)	BSPP / BSPT / NPT 1/4	
Weight	0.50 kg (1.10 lbs)	

* Inlet pressure 10 bar (145 psig). Secondary pressure 6.3 bar (91.3) psig.

Materials of Construction

Body	Zinc	
Adjustment Knob	Acetal	
Body Cap	ABS	
Bonnet	33% Glass-filled nylon	
Diaphragm Assembly	Nitrile / Zinc	
Bottom Plug	33% Glass-filled Nylon	
Valve Assembly	Brass / Nitrile	
Springs	Main Regulating Valve	Steel
		S.S.
Seals	Nitrile	
Panel Nut	Acetal	

Dimensions

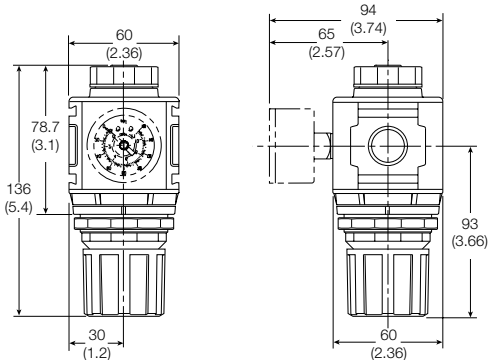

NOTE: 51 mm (2.00 in.) hole required for panel nut mounting.



WARNING

**Product rupture can cause serious injury.
Do not connect regulator to bottled gas.
Do not exceed Maximum primary pressure rating.**

CAUTION:

REGULATOR PRESSURE ADJUSTMENT – The working range of knob adjustment is designed to permit outlet pressures within their full range. Pressure adjustment beyond this range is also possible because the knob is not a limiting device. This is a common characteristic of most industrial regulators, and limiting devices may be obtained only by special design. For best performance, regulated pressure should always be set by increasing the pressure up to the desired setting.

Flow Charts

P32 Common Port Regulator

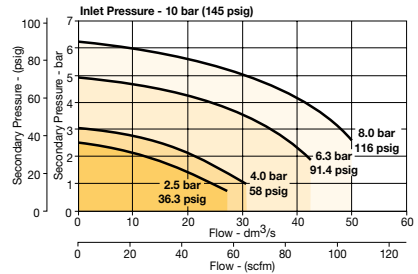

Repair and Service Kits

Regulator repair kit - Relieving	P32KA00RB
Regulator repair kit - Non-relieving	P32KA00RC
Panel mount nut - Aluminum	P32KA00MM
Panel mount nut - Plastic	P32KA00MP
Angle Bracket (uses panel mount threads)	P32KA00MR
T-Bracket with body connector	P32KA00MT
T-Bracket	P32KA00MB
Body connector	P32KA00CB

Gauges

50mm (2") Round 1/4" center back mount

0-2 bar / 0-0.2 Mpa / 0-30 psig	K4520R1402B
0-4 bar / 0-0.4 Mpa / 0-60 psig	K4520R1404B
0-11 bar / 0-1.1 Mpa / 0-160 psig	K4520R1411B
0-20 bar / 0-2 Mpa / 0-300 psig	K4520R1420B

For best performance, regulated pressure should always be set by increasing the pressure up to the desired setting.

Parker One Pneumatic

Standard Regulator - P33



Symbols

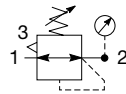

Self relieving regulator with gauge

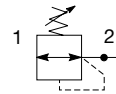

Non relieving regulator

- Integral 1/2" or 3/4" ports (NPT, BSPP & BSPT)
- Robust but lightweight aluminum construction
- Secondary pressure ranges 0-2 bar (0-30 psig), 0-4 bar, (0-60 psig), 0-8 bar (0-125 psig), 0-17 bar (0-250 psig)
- Secondary aspiration plus balanced poppet provides quick response and accurate pressure regulation
- Relieving & Non-relieving types
- Non-rising knob

Options:

P 33	RA				N		P																																														
<table border="1" style="width: 100%; border-collapse: collapse;"> <tr><th colspan="2">Thread type</th></tr> <tr><td>BSPP</td><td style="text-align: center;">1</td></tr> <tr><td>BSPT</td><td style="text-align: center;">2</td></tr> <tr><td>NPT</td><td style="text-align: center;">9</td></tr> </table>		Thread type		BSPP	1	BSPT	2	NPT	9	<table border="1" style="width: 100%; border-collapse: collapse;"> <tr><th colspan="2">Port size</th></tr> <tr><td>1/2</td><td style="text-align: center;">4</td></tr> <tr><td>3/4</td><td style="text-align: center;">6</td></tr> </table>		Port size		1/2	4	3/4	6	<table border="1" style="width: 100%; border-collapse: collapse;"> <tr><th colspan="2">Relief</th></tr> <tr><td>Relieving</td><td style="text-align: center;">B</td></tr> <tr><td>Non relieving</td><td style="text-align: center;">N</td></tr> <tr><td>Reverse flow / relieving</td><td style="text-align: center;">R</td></tr> </table>				Relief		Relieving	B	Non relieving	N	Reverse flow / relieving	R	<table border="1" style="width: 100%; border-collapse: collapse;"> <tr><th colspan="2">Adjustment range</th></tr> <tr><th colspan="2">With round gauge</th></tr> <tr><td>2 bar; 30 psig; 0.2 MPa</td><td style="text-align: center;">Z</td></tr> <tr><td>4 bar; 60 psig; 0.4 MPa</td><td style="text-align: center;">M</td></tr> <tr><td>8 bar; 125 psig; 0.8 MPa</td><td style="text-align: center;">G</td></tr> <tr><td>17 bar; 250 psig; 1.7 MPa</td><td style="text-align: center;">J</td></tr> <tr><th colspan="2">Without gauge</th></tr> <tr><td>2 bar; 30 psig; 0.2 MPa</td><td style="text-align: center;">Y</td></tr> <tr><td>4 bar; 60 psig; 0.4 MPa</td><td style="text-align: center;">L</td></tr> <tr><td>8 bar; 125 psig; 0.8 MPa</td><td style="text-align: center;">N</td></tr> <tr><td>17 bar; 250 psig; 1.7 MPa</td><td style="text-align: center;">H</td></tr> </table>		Adjustment range		With round gauge		2 bar; 30 psig; 0.2 MPa	Z	4 bar; 60 psig; 0.4 MPa	M	8 bar; 125 psig; 0.8 MPa	G	17 bar; 250 psig; 1.7 MPa	J	Without gauge		2 bar; 30 psig; 0.2 MPa	Y	4 bar; 60 psig; 0.4 MPa	L	8 bar; 125 psig; 0.8 MPa	N	17 bar; 250 psig; 1.7 MPa	H
Thread type																																																					
BSPP	1																																																				
BSPT	2																																																				
NPT	9																																																				
Port size																																																					
1/2	4																																																				
3/4	6																																																				
Relief																																																					
Relieving	B																																																				
Non relieving	N																																																				
Reverse flow / relieving	R																																																				
Adjustment range																																																					
With round gauge																																																					
2 bar; 30 psig; 0.2 MPa	Z																																																				
4 bar; 60 psig; 0.4 MPa	M																																																				
8 bar; 125 psig; 0.8 MPa	G																																																				
17 bar; 250 psig; 1.7 MPa	J																																																				
Without gauge																																																					
2 bar; 30 psig; 0.2 MPa	Y																																																				
4 bar; 60 psig; 0.4 MPa	L																																																				
8 bar; 125 psig; 0.8 MPa	N																																																				
17 bar; 250 psig; 1.7 MPa	H																																																				
							<table border="1" style="width: 100%; border-collapse: collapse;"> <tr><th colspan="2">Mounting</th></tr> <tr><td>Plastic panel mount nut</td><td style="text-align: center;">P</td></tr> </table>	Mounting		Plastic panel mount nut	P																																										
Mounting																																																					
Plastic panel mount nut	P																																																				

Port size	Description	Order Code [†]	Flow dm ³ /s (scfm)	Max. bar (psig)	Height mm (inches)	Width mm (inches)	Depth mm (inches)
1/2"	8 bar (125 psig) Relieving	P33RA24BNNP	100 (212)	20 (300)	149 (5.9)	73 (2.9)	73 (2.9)
1/2"	8 bar (125 psig) Relieving + Gauge	P33RA24BNGP	100 (212)	20 (300)	149 (5.9)	73 (2.9)	73 (2.9)
3/4"	8 bar (125 psig) Relieving	P33RA26BNNP	100 (212)	20 (300)	149 (5.9)	73 (2.9)	73 (2.9)
3/4"	8 bar (125 psig) Relieving + Gauge	P33RA26BNGP	100 (212)	20 (300)	149 (5.9)	73 (2.9)	73 (2.9)

* flow with 10 bar (145 psig) inlet pressure, 6.3 bar (91.3 psig) set pressure and 1 bar (14.5 psig) pressure drop.

† Standard part numbers shown in bold. For other models refer to Options chart above.

Parker One Pneumatic

Specifications

Flow Capacity*	1/2	100 dm ³ /s (212 scfm)
	3/4	100 dm ³ /s (212 scfm)
Max. Operating Temperature	65.5°C (150°F)	
Max. Supply Pressure	20 bar (300 psig)	
Adjusting Range Pressure	0-2 bar (30 psig)	
	0-4 bar (60 psig)	
	0-8 bar (125 psig)	
	0-17 bar (250 psig)	
Port Size	BSPP / BSPT / NPT	1/2, 3/4
Gauge Port (2 ea.)	BSPP / BSPT / NPT	1/4
Weight	0.62 kg (1.37 lbs)	

* Inlet pressure 10 bar (145 psig). Secondary pressure 6.3 bar (91.3 psig).

Materials of Construction

Body	Aluminum	
Adjustment Knob	Acetal	
Body Cap	ABS	
Bonnet	33% Glass-filled Nylon	
Diaphragm Assembly	Nitrile / Zinc	
Valve Assembly	Brass / Nitrile / Acetal	
Springs	Main Regulating Valve	Steel S.S.
Seals	Nitrile	
Panel Nut	Acetal	

Dimensions

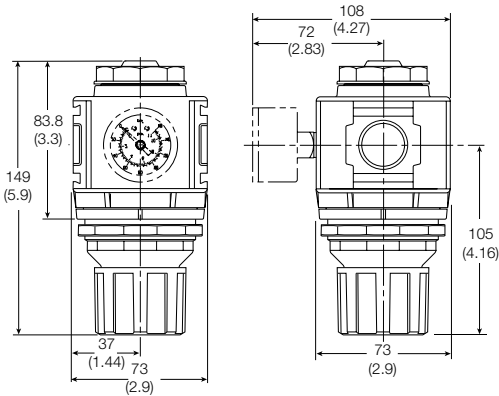

NOTE: 61 mm (2.40 in.) hole required for panel nut mounting.



WARNING

Product rupture can cause serious injury. Do not connect regulator to bottled gas. Do not exceed Maximum primary pressure rating.

CAUTION:

REGULATOR PRESSURE ADJUSTMENT – The working range of knob adjustment is designed to permit outlet pressures within their full range. Pressure adjustment beyond this range is also possible because the knob is not a limiting device. This is a common characteristic of most industrial regulators, and limiting devices may be obtained only by special design. For best performance, regulated pressure should always be set by increasing the pressure up to the desired setting.

Flow Charts

1/2 Regulator

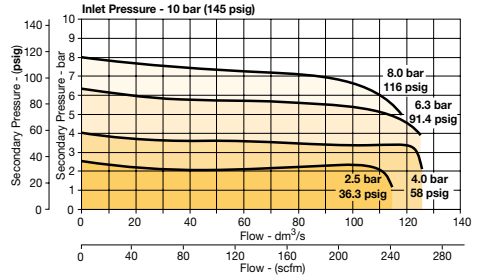

3/4 Regulator

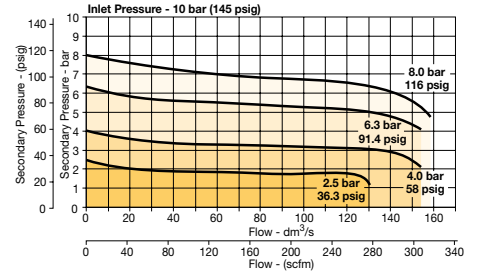

Repair and Service Kits

Regulator repair kit - Relieving	P33KA00RB
Regulator repair kit - Non-relieving	P33KA00RC
Panel mount nut - Aluminum	P33KA00MM
Panel mount nut - Plastic	P33KA00MP
Angle Bracket (uses panel mount threads)	P33KA00MR
T-Bracket with body connector	P32KA00MT
T-Bracket	P32KA00MB
Body connector	P32KA00CB

Gauges

50mm (2") Round 1/4" center back mount

0-2 bar / 0-0.2 Mpa / 0-30 psig	K4520R1402B
0-4 bar / 0-0.4 Mpa / 0-60 psig	K4520R1404B
0-11 bar / 0-1.1 Mpa / 0-160 psig	K4520R1411B
0-20 bar / 0-2 Mpa / 0-300 psig	K4520R1420B

For best performance, regulated pressure should always be set by increasing the pressure up to the desired setting.

Mini Filter / Regulator - P31

Symbols

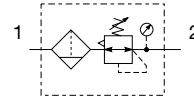

- Integral 1/4" ports (NPT, BSPP & BSPT)
- High efficiency 5 micron element as standard
- Excellent water removal efficiency
- Robust but lightweight aluminum construction
- Positive bayonet latch to ensure correct & safe fitting
- Secondary pressure ranges 0-2 bar (0-30 psig), 0-4 bar, (0-60 psig), 0-8 bar (0-125 psig)
- Secondary aspiration plus balanced poppet provides quick response and accurate pressure regulation

Options:

P 3 1	E A			E					N		P
Thread type		Drain type		Relief		Adjustment range					
BSPP	1	Pulse drain	B	Relieving	B	With square gauge	With round gauge	Without gauge			
BSPT	2	Manual drain	M	Non relieving	N	2 bar (0.2 MPa)*	2 2 bar (0.2 MPa)	Z 2 bar (0.2 MPa)	Y		
NPT	9					4 bar (0.4 MPa)*	4 4 bar (0.4 MPa)	M 4 bar (0.4 MPa)	L		
Port size						8 bar (0.8 MPa)**	6 8 bar (0.8 MPa)	G 8 bar (0.8 MPa)	N		
1/8	1										
1/4	2										
Element											
5µ Element	E										
Bowl type											
Poly bowl with bowl guard	G										
Metal bowl without sight gauge	M										
Mounting											
Plastic panel mount nut											

Port size	Description	Order Code†	Flow dm ³ /s (scfm)	Max. bar (psig)	Height mm (inches)	Width mm (inches)	Depth mm (inches)
1/4"	8 bar (125 psig) Relieving - Poly bowl - Manual drain	P31EA22EGMBN6P	14 (30)	10 (150)	164.1 (6.46)	40 (1.58)	64 (2.53)
1/4"	8 bar (125 psig) Relieving - Poly bowl - Pulse drain	P31EA22EGBBN6P	14 (30)	10 (150)	164.1 (6.46)	40 (1.58)	64 (2.53)
1/4"	8 bar (125 psig) Relieving - Metal bowl - Manual drain	P31EA22EMMBN6P	14 (30)	17 (250)	164.1 (6.46)	40 (1.58)	64 (2.53)
1/4"	8 bar (125 psig) Relieving - Metal bowl - Pulse drain	P31EA22EMBBN6P	14 (30)	17 (250)	164.1 (6.46)	40 (1.58)	64 (2.53)

* flow with 10 bar (145 psig) inlet pressure, 6.3 bar (91.3 psig) set pressure and 1 bar (14.5 psig) pressure drop.

† Standard part numbers shown in bold. For other models refer to Options chart above.

Specifications

Flow Capacity*	1/4	14 dm ³ /s (30.0 scfm)
Max. Operating Temperature	Plastic Bowl	52°C (125°F)
	Metal Bowl	65.5°C (150°F)
Max. Supply Pressure	Plastic Bowl	10 bar (150 psig)
	Metal Bowl	17 bar (250 psig)
Standard Filtration	5 Micron	
Useful Retention	12 cm ³ (0.4 US oz.)	
Adjusting Range	0-2 bar (30 psig)	
Pressure	0-4 bar (60 psig)	
	0-8 bar (125 psig)	

Port Size	BSPP / BSPT / NPT	
Gauge Port (2 ea.)**	BSPP / BSPT / NPT	
Weight	0.19 kg (0.42 lbs)	

* Inlet pressure 10 bar (145 psig). Secondary pressure 6.3 bar (91.3 psig).
 ** Non-gauge option only.

Air quality:

Within ISO 8573-1: 1991 Class 3 (Particulates)
 Within ISO 8573-1: 2001 Class 6 (Particulates)

Materials of Construction

Body	Aluminum	
Adjustment Knob	Acetal	
Body Cap	ABS	
Bonnet	PBT	
Bowl	Plastic Bowl	Polycarbonate
	Metal Bowl	Aluminum
Bowl Guard	Nylon	
Filter Element	Polyethylene	
Seals	Plastic Bowl	Nitrile
	Metal Bowl	Nitrile
Springs	Steel	
Valve Assembly	Brass / Nitrile	
Diaphragm Assembly	Brass / Nitrile	
Panel Nut	Acetal	

For best performance, regulated pressure should always be set by increasing the pressure up to the desired setting.

Dimensions

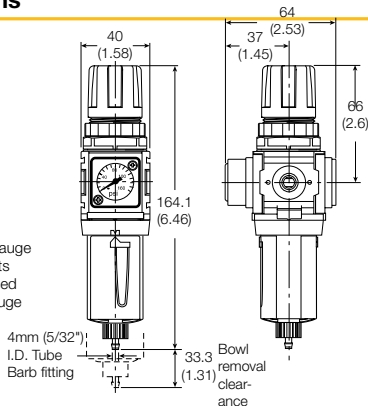

Note:
 Flush-mounted gauge kits will not fit units originally purchased with threaded gauge ports.

⚠ WARNING

**Product rupture can cause serious injury.
 Do not connect regulator to bottled gas.
 Do not exceed Maximum primary pressure rating.**

Flow Charts

1/4 Filter/Regulator

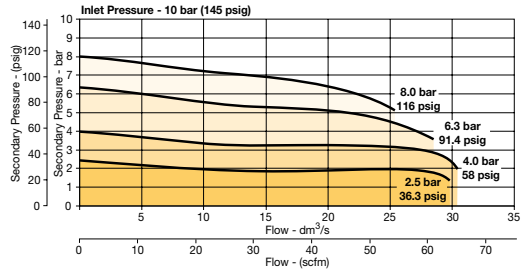

Repair and Service Kits

Plastic bowl / Bowl guard manual drain	P31KA00BGM
Metal bowl / w/o sight gauge manual drain	P31KA00BMM
Plastic bowl / Bowl guard pulse drain	P31KA00BGB
Metal bowl / w/o sight gauge pulse drain	P31KA00BMB
5µ particle filter element	P31KA00ESE
Regulator repair kit - Relieving	P31KA00RB
Regulator repair kit - Non-relieving	P31KA00RC
Panel mount nut - Aluminum	P31KA00MM
Panel mount nut - Plastic	P31KA00MP
Angle Bracket (uses panel mount threads)	P31KA00MR
C-Bracket (fits to body)	P31KA00MW
T-Bracket with body connector	P31KA00MT
Body connector	P31KA00CB

Gauges

Square flush mount gauge

0-4 bar	K4511SCR04B
0-10 bar	K4511SCR11B
0-60 psig	K4511SCR060
0-150 psig	K4511SCR150
0-0.4 Mpa	K45SCR04M
0-1.1 Mpa	K45SCR11M

40mm Round 1/8" center back mount

(Not for use with Common Port Regulators)

0-2 bar (0-0.2 Mpa)	K4515R1402B
0-4 bar (0-0.4 Mpa)	K4515R1404B
0-8 bar (0-0.8 Mpa)	K4515R1411B

For best performance, regulated pressure should always be set by increasing the pressure up to the desired setting.

Compact Filter / Regulator - P32

Symbols

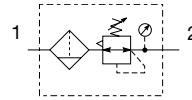

- Integral 1/4", 3/8" or 1/2" ports (NPT, BSPP & BSPT)
- High efficiency 5 micron element as standard
- Excellent water removal efficiency
- Robust but lightweight aluminum construction
- Positive bayonet latch to ensure correct & safe fitting
- Secondary pressure ranges 0-2 bar (0-30 psig), 0-4 bar, (0-60 psig), 0-8 bar (0-125 psig), 0-17 bar (0-250 psig)
- Secondary aspiration plus balanced poppet provides quick response and accurate pressure regulation

Options:

P 3 2	E A			E				N		P
--------------	------------	--	--	----------	--	--	--	----------	--	----------

Thread type	
BSPP	1
BSPT	2
NPT	9

Port size	
1/4	2
3/8	3
1/2	4

Drain type	
Manual drain	M
Auto drain	A

Mounting	
Plastic panel mount nut	P

Element	
5µ Element	E

Relief	
Relieving	B
Non relieving	N

Adjustment range	
With round gauge	
2 bar; 30 psig; 0.2 MPa	Z
4 bar; 60 psig; 0.4 MPa	M
8 bar; 125 psig; 0.8 MPa	G
17 bar; 250 psig; 1.7 MPa	J
Without gauge	
2 bar; 30 psig; 0.2 MPa	Y
4 bar; 60 psig; 0.4 MPa	L
8 bar; 125 psig; 0.8 MPa	N
17 bar; 250 psig; 1.7 MPa	H

Bowl type	
Poly bowl with bowl guard	G
Metal bowl without sight gauge	M
Metal bowl with sight gauge	S

Port size	Description	Order Code†	Flow dm ³ /s (scfm)	Max. bar (psig)	Height mm (inches)	Width mm (inches)	Depth mm (inches)
1/4"	8 bar (125 psig) Relieving - Poly bowl - Manual drain	P32EA22EGMBNGP	42 (89)	10 (150)	254 (10.0)	60 (2.36)	60 (2.36)
1/4"	8 bar (125 psig) Relieving - Poly bowl - Auto drain	P32EA22EGABNGP	42 (89)	10 (150)	248 (9.76)	60 (2.36)	60 (2.36)
1/4"	8 bar (125 psig) Relieving - Metal bowl - Manual drain	P32EA22ESMBNGP	42 (89)	17 (250)	245 (9.66)	60 (2.36)	60 (2.36)
1/4"	8 bar (125 psig) Relieving - Metal bowl - Auto drain	P32EA22ESABNGP	42 (89)	17 (250)	254 (10.0)	60 (2.36)	95 (3.74)
3/8"	8 bar (125 psig) Relieving - Poly bowl - Manual drain	P32EA23EGMBNGP	58 (123)	10 (150)	254 (10.0)	60 (2.36)	60 (2.36)
3/8"	8 bar (125 psig) Relieving - Poly bowl - Auto drain	P32EA23EGABNGP	58 (123)	10 (150)	248 (9.76)	60 (2.36)	60 (2.36)
3/8"	8 bar (125 psig) Relieving - Metal bowl - Manual drain	P32EA23ESMBNGP	58 (123)	17 (250)	245 (9.66)	60 (2.36)	60 (2.36)
3/8"	8 bar (125 psig) Relieving - Metal bowl - Auto drain	P32EA23ESABNGP	58 (123)	17 (250)	254 (10.0)	60 (2.36)	95 (3.74)
1/2"	8 bar (125 psig) Relieving - Poly bowl - Manual drain	P32EA24EGMBNGP	64 (136)	10 (150)	245 (9.66)	60 (2.36)	95 (3.74)
1/2"	8 bar (125 psig) Relieving - Poly bowl - Auto drain	P32EA24EGABNGP	64 (136)	10 (150)	248 (9.76)	60 (2.36)	95 (3.74)
1/2"	8 bar (125 psig) Relieving - Metal bowl - Manual drain	P32EA24ESMBNGP	64 (136)	17 (250)	245 (9.66)	60 (2.36)	60 (2.36)
1/2"	8 bar (125 psig) Relieving - Metal bowl - Auto drain	P32EA24ESABNGP	64 (136)	17 (250)	254 (10.0)	60 (2.36)	60 (2.36)

* flow with 10 bar (145 psig) inlet pressure, 6.3 bar (91.3 psig) set pressure and 1 bar (14.5 psig) pressure drop.
 † Standard part numbers shown in bold. For other models refer to Options chart above.

Specifications

Flow Capacity*	1/4	42 dm ³ /s (89 scfm)
	3/8	58 dm ³ /s (123 scfm)
	1/2	64 dm ³ /s (136 scfm)
Max. Operating Temperature	Plastic Bowl	52°C (125°F)
	Metal Bowl	65.5°C (150°F)
Max. Supply Pressure	Plastic Bowl	10 bar (150 psig)
	Metal Bowl	17 bar (250 psig)
Standard Filtration		5 Micron
Useful Retention†		51 cm ³ (1.7 US oz.)
Adjusting Range Pressure		0-2 bar (30 psig)
		0-4 bar (60 psig)
		0-8 bar (125 psig)
		0-17 bar (250 psig)
Port Size	BSP / BSPT / NPT	1/4, 3/8, 1/2
Gauge Port (2 ea.)	BSP / BSPT / NPT	1/4
Weight		0.53 kg (1.17 lbs)

* Inlet pressure 10 bar (145 psig). Secondary pressure 6.3 bar (91.3 psig).
 † Useful retention refers to volume below the quiet zone baffle.

Air quality:

Within ISO 8573-1: 1991 Class 3 (Particulates)
 Within ISO 8573-1: 2001 Class 6 (Particulates)

Materials of Construction

Body	Aluminum	
Adjustment Knob	Acetal	
Body Cap	ABS	
Element Retainer / Baffle	Acetal	
Bowl	Plastic Bowl	Polycarbonate
	Metal Bowl	Zinc
Bowl Guard	Nylon	
Filter Element	Sintered Polyethylene	
Seals	Plastic Bowl	Nitrile
	Metal Bowl	Nitrile
Springs	Main Regulating / Valve	Steel / S.S.
Valve Assembly	Brass / Nitrile	
Diaphragm Assembly	Nitrile / Zinc	
Panel Nut	Acetal	
Sight Gauge	Metal Bowl	Polycarbonate

Dimensions

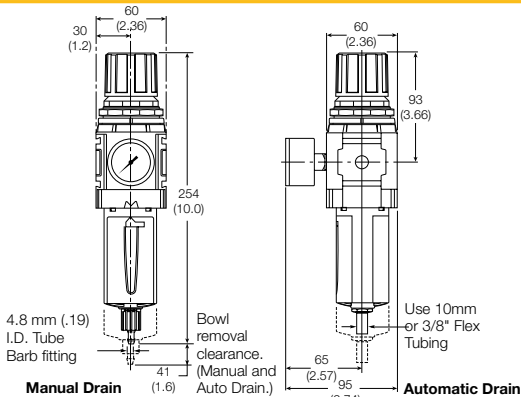

WARNING
 Product rupture can cause serious injury.
 Do not connect regulator to bottled gas.
 Do not exceed Maximum primary pressure rating.

Flow Charts

1/4 Filter/Regulator

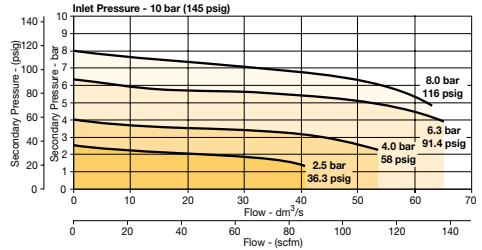

3/8 Filter/Regulator

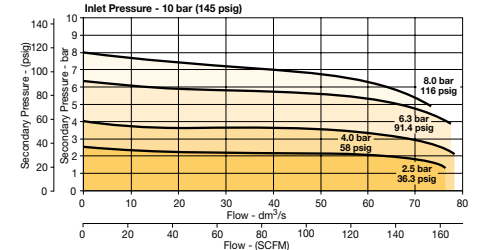

1/2 Filter/Regulator

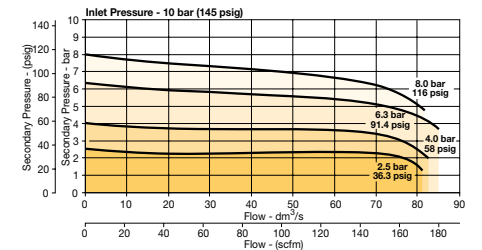

Repair and Service Kits

Plastic bowl / Bowl guard manual drain	P32KA00BGM
Metal bowl / Sight gauge manual drain	P32KA00BSM
Auto drain	P32KA00DA
5µ particle filter element	P32KA00ESE
Regulator repair kit - Relieving	P32KA00RB
Regulator repair kit - Non-relieving	P32KA00RC
Panel mount nut - Aluminum	P32KA00MM
Panel mount nut - Plastic	P32KA00MP
Angle Bracket (fits to panel mount threads)	P32KA00MR
T-Bracket (fits to body connector)	P32KA00MB
T-Bracket with body connector	P32KA00MT
Body connector	P32KA00CB

Gauges

50mm (2") Round 1/4" center back mount

0-2 bar / 0-0.2 Mpa / 0-30 psig	K4520R1402B
0-4 bar / 0-0.4 Mpa / 0-60 psig	K4520R1404B
0-11 bar / 0-1.1 Mpa / 0-160 psig	K4520R1411B
0-20 bar / 0-2 Mpa / 0-300 psig	K4520R1420B

For best performance, regulated pressure should always be set by increasing the pressure up to the desired setting.

Standard Filter / Regulator - P33

Symbols

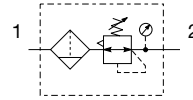

- Integral 1/2" or 3/4" ports (NPT, BSPP & BSPT)
- High efficiency 5 micron element as standard
- Excellent water removal efficiency
- Robust but lightweight aluminum construction
- Positive bayonet latch to ensure correct & safe fitting
- Secondary pressure ranges 0-2 bar (0-30 psig), 0-4 bar, (0-60 psig), 0-8 bar (0-125 psig), 0-17 bar (0-250 psig)
- Secondary aspiration plus balanced poppet provides quick response and accurate pressure regulation

Options:

P 33	EA			E				N		P
Thread type		Port size		Drain type		Element		Relief		Mounting
BSPP	1	1/2	4	Manual drain	M	5µ Element	E	Relieving	B	Plastic panel
BSPT	2	3/4	6	Auto drain	A			Non relieving	N	Mount nut
NPT	9									
						Bowl type				Adjustment range
						Poly bowl with bowl guard				With round gauge
						Metal bowl without sight gauge				2 bar; 30 psig; 0.2 MPa
						Metal bowl with sight gauge				4 bar; 60 psig; 0.4 MPa
										8 bar; 125 psig; 0.8 MPa
										17 bar; 250 psig; 1.7 MPa
										Without gauge
										2 bar; 30 psig; 0.2 MPa
										4 bar; 60 psig; 0.4 MPa
										8 bar; 125 psig; 0.8 MPa
										17 bar; 250 psig; 1.7 MPa
										Z
										M
										G
										J
										Y
										L
										N
										H

Port size	Description	Order Code†	Flow dm ³ /s (scfm)	Max. bar (psig)	Height mm (inches)	Width mm (inches)	Depth mm (inches)
1/2"	8 bar (125 psig) Relieving - Poly bowl - Manual drain	P33EA24EGMBNGP	90 (191)	10 (150)	291 (11.44)	73 (2.9)	73 (2.9)
1/2"	8 bar (125 psig) Relieving - Poly bowl - Auto drain	P33EA24EGABNGP	90 (191)	10 (150)	285 (11.22)	73 (2.9)	73 (2.9)
1/2"	8 bar (125 psig) Relieving - Metal bowl - Manual drain	P33EA24ESMBNGP	90 (191)	17 (250)	282 (11.0)	73 (2.9)	73 (2.9)
1/2"	8 bar (125 psig) Relieving - Metal bowl - Auto drain	P33EA24ESABNGP	90 (191)	17 (250)	291 (11.44)	73 (2.9)	108 (4.27)
3/4"	8 bar (125 psig) Relieving - Poly bowl - Manual drain	P33EA26EGMBNGP	98 (208)	10 (150)	282 (11.0)	73 (2.9)	108 (4.27)
3/4"	8 bar (125 psig) Relieving - Poly bowl - Auto drain	P33EA26EGABNGP	98 (208)	10 (150)	285 (11.22)	73 (2.9)	108 (4.27)
3/4"	8 bar (125 psig) Relieving - Metal bowl - Manual drain	P33EA26ESMBNGP	98 (208)	17 (250)	291 (11.44)	73 (2.9)	73 (2.9)
3/4"	8 bar (125 psig) Relieving - Metal bowl - Auto drain	P33EA26ESABNGP	98 (208)	17 (250)	282 (11.0)	73 (2.9)	73 (2.9)

* flow with 10 bar (145 psig) inlet pressure, 6.3 bar (91.3 psig) set pressure and 1 bar (14.5 psig) pressure drop.

† Standard part numbers shown in bold. For other models refer to Options chart above.

Specifications

Flow Capacity*	1/2	90 dm ³ /s (191 scfm)
	3/4	98 dm ³ /s (208 scfm)
Max. Operating Temperature	Plastic Bowl	52°C (125°F)
	Metal Bowl	65.5°C (150°F)
Supply Pressure	Plastic Bowl	10 bar (150 psig)
	Metal Bowl	17 bar (250 psig)
Standard Filtration		5 Micron
Useful Retention†		85 cm ³ (2.8 US oz.)
Adjusting Range		0-2 bar (30 psig)
Pressure		0-4 bar (60 psig)
		0-8 bar (125 psig)
		0-17 bar (250 psig)
Port Size	BSPP / BSPT / NPT	1/2, 3/4
Gauge Port (2 ea.)	BSPP / BSPT / NPT	1/4
Weight		0.85 kg (1.87 lbs)

* Inlet pressure 10 bar (145 psig). Secondary pressure 6.3 bar (91.3) psig.
 † Useful retention refers to volume below the quiet zone baffle.

Air quality:

Within ISO 8573-1: 1991 Class 3 (Particulates)
 Within ISO 8573-1: 2001 Class 6 (Particulates)

Materials of Construction

Body	Aluminum	
Adjustment Knob	Acetal	
Body Cap	ABS	
Element Retainer / Baffle	Acetal	
Bowls	Plastic Bowl	Polycarbonate
	Metal Bowl	Aluminum
Filter Element	Sintered Polyethylene	
Seals	Plastic Bowl	Nitrile
	Metal Bowl	Nitrile
Springs	Main Regulating / Valve	Steel / S.S.
Valve Assembly	Brass / Nitrile	
Diaphragm Assembly	Nitrile / Zinc	
Panel Nut	Acetal	
Sight Gauge	Metal Bowl	Polycarbonate

Dimensions

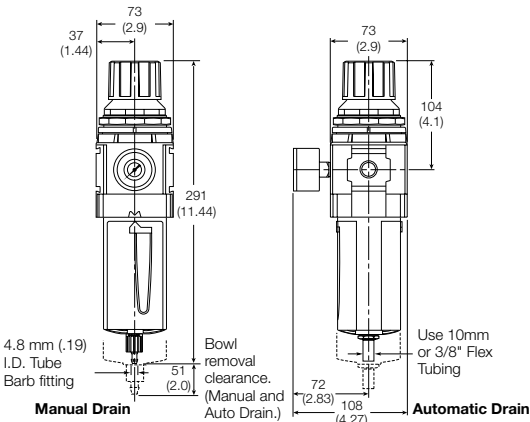

⚠ WARNING
Product rupture can cause serious injury. Do not connect regulator to bottled gas. Do not exceed Maximum primary pressure rating.

Flow Charts

1/2 Filter/Regulator

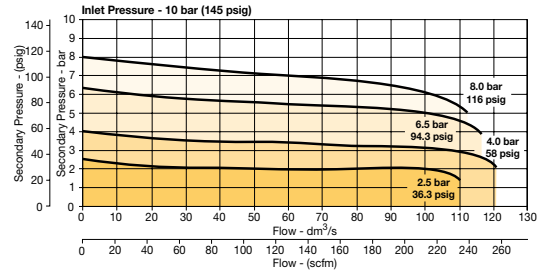

3/4 Filter/Regulator

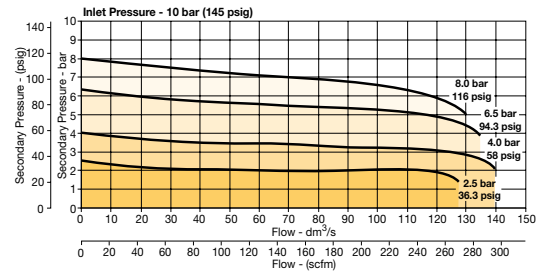

Repair and Service Kits

Plastic bowl / Bowl guard manual drain	P33KA00BGM
Metal bowl / Sight gauge manual drain	P33KA00BSM
Auto drain	P32KA00DA
5µ particle filter element	P33KA00ESE
Regulator repair kit - Relieving	P33KA00RB
Regulator repair kit - Non-relieving	P33KA00RC
Panel mount nut - Aluminum	P33KA00MM
Panel mount nut - Plastic	P33KA00MP
Angle Bracket (fits to panel mount threads)	P33KA00MR
T-Bracket (fits to body connector)	P32KA00MB
T-Bracket with body connector	P32KA00MT
Body connector	P32KA00CB

Gauges

50mm (2") Round 1/4" center back mount

0-2 bar / 0-0.2 Mpa / 0-30 psig	K4520R1402B
0-4 bar / 0-0.4 Mpa / 0-60 psig	K4520R1404B
0-11 bar / 0-1.1 Mpa / 0-160 psig	K4520R1411B
0-20 bar / 0-2 Mpa / 0-300 psig	K4520R1420B

For best performance, regulated pressure should always be set by increasing the pressure up to the desired setting.

Mini Lubricator - P31



Symbols

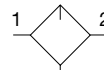

Lubricator with drain

- Integral 1/4" ports (NPT, BSPP & BSPT)
- Robust but lightweight aluminum construction
- Proportional oil delivery over a wide range of air flows
- Finger tip ratchet control for precise oil drip rate adjustment

Options:

P 3 1	LA			L		N	N
Thread type		Port size		Bowl type		Mounting	
BSPP	1	1/8	1	Poly bowl with bowl guard	G	No bracket	N
BSPT	2	1/4	2	Metal bowl without sight gauge	M		
NPT	9						
Type				Drain type			
Oil mist standard sight dome				No drain; closed end			
				L			
				N			

Port size	Description	Order Code [†]	Flow dm ³ /s (scfm)	Max. bar (psig)	Height mm (inches)	Width mm (inches)	Depth mm (inches)
1/4"	Poly bowl - No drain	P31LA22LGNN	13 (28)	10 (150)	147.5 (5.80)	40 (1.58)	42.7 (1.68)
1/4"	Metal bowl - No drain	P31LA22LMNN	13 (28)	17 (250)	147.5 (5.80)	40 (1.58)	42.7 (1.68)

* flow with 6.3 bar (91.3 psig) inlet pressure and 0.34 bar (4.9 psig) pressure drop.

† Standard part numbers shown in bold. For other models refer to Options chart above.

Specifications

Flow Capacity*	1/4	13 dm ³ /s (28 scfm)
Max. Operating Temperature	Plastic Bowl	52°C (125°F)
	Metal Bowl	65.5°C (150°F)
Max. Supply Pressure	Plastic Bowl	10 bar (150 psig)
	Metal Bowl	17 bar (250 psig)
Useful Retention		18 cm ³ (0.6 US oz.)
Port Size	BSPP / BSPT / NPT	1/4
Weight		0.13 kg (0.29 lbs)

* Inlet pressure 6.3 bar (91.3 psig). Pressure drop 0.34 bar (4.9 psig).

Materials of Construction

Body		Aluminum
Body Cap		ABS
Bowl	Plastic Bowl	Polycarbonate
	Metal Bowl	Aluminum
Seals	Plastic Bowl	Nitrile
	Metal Bowl	Nitrile
Sight Dome		Polycarbonate
Suggested Lubricant		ISO / ASTM VG32
Pick-up Filter		Sintered Bronze

Flow Charts

1/4 Lubricator

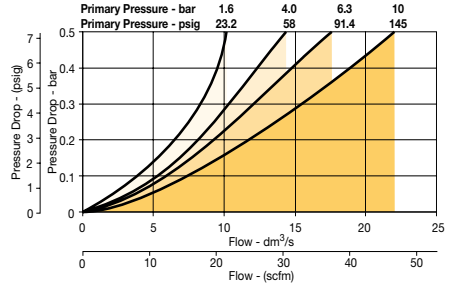

Dimensions

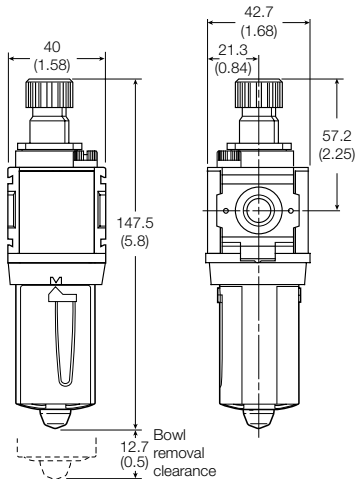

Repair and Service Kits

Plastic bowl / Bowl guard no drain	P31KA00BGN
Drip control assembly	P32KA00PG
Fill plug	P31KA00PL
C-Bracket (fits to body)	P31KA00MW
T-Bracket with body connector	P31KA00MT
Body connector	P31KA00CB

Suggested Lubricant F442 Oil

Petroleum based oil of 100 to 200 SUS viscosity at 38°C (100°F) and an aniline point greater than 93°C (200°F) (DO NOT USE OILS WITH ADDITIVES, COMPOUNDED OILS CONTAINING SOLVENTS, GRAPHITE, DETERGENTS, OR SYNTHETIC OILS.)

Compact Lubricator - P32



Symbols

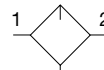

Lubricator with drain

- Integral 1/4", 3/8" or 1/2" ports (NPT, BSPP & BSPT)
- Robust but lightweight aluminum construction
- Proportional oil delivery over a wide range of air flows
- Finger tip ratchet control for precise oil drip rate adjustment
- Fill from top under system pressure

Options:

P 3 2	LA			L		N	N
Thread type		Port size		Bowl type		Mounting	
BSPP	1	1/4	2	Poly bowl with bowl guard	G	No bracket	
BSPT	2	3/8	3	Metal bowl with sight gauge	S		
NPT	9	1/2	4				
Type				Drain type			
Oil mist standard sight dome				No drain; closed end			
				L			
				N			

Port size	Description	Order Code†	Flow dm ³ /s (scfm)	Max. bar (psig)	Height mm (inches)	Width mm (inches)	Depth mm (inches)
1/4"	Poly bowl - No drain	P32LA22LGNN	18 (38)	10 (150)	211 (8.30)	60 (2.36)	60 (2.36)
1/4"	Metal bowl - No drain	P32LA22LSNN	18 (38)	17 (250)	211 (8.30)	60 (2.36)	60 (2.36)
3/8"	Poly bowl - No drain	P32LA23LGNN	32 (68)	10 (150)	211 (8.30)	60 (2.36)	60 (2.36)
3/8"	Metal bowl - No drain	P32LA23LSNN	32 (68)	17 (250)	211 (8.30)	60 (2.36)	60 (2.36)
1/2"	Poly bowl - No drain	P32LA24LGNN	47 (100)	10 (150)	211 (8.30)	60 (2.36)	60 (2.36)
1/2"	Metal bowl - No drain	P32LA24LSNN	47 (100)	17 (250)	211 (8.30)	60 (2.36)	60 (2.36)

* flow with 6.3 bar (91.3 psig) inlet pressure and 0.34 bar (4.9 psig) pressure drop.

† **Standard part numbers shown in bold. For other models refer to Options chart above.**

Specifications

Flow Capacity*	1/4	18 dm ³ /s (38 scfm)
	3/8	32 dm ³ /s (68 scfm)
	1/2	47 dm ³ /s (100 scfm)
Max. Operating Temperature	Plastic Bowl	52°C (125°F)
	Metal Bowl	65.5°C (150°F)
Max. Supply Pressure	Plastic Bowl	10 bar (150 psig)
	Metal Bowl	17 bar (250 psig)
Useful Retention		121 cm ³ (4.09 US oz.)
Port Size	BSPP / BSPT / NPT 1/4, 3/8, 1/2	
Weight		0.31 kg (0.68 lbs)

* Inlet pressure 6.3 bar (91.3 psig). Pressure drop 0.34 bar (4.9 psig).

Materials of Construction

Body	Aluminum	
Body Cap	ABS	
Bowls	Plastic Bowl	Polycarbonate
	Metal Bowl	Aluminum
Seals	Plastic Bowl	Nitrile
	Metal Bowl	Nitrile
Sight Dome	Polycarbonate	
Sight Gauge	Metal Bowl	Polycarbonate
Suggested Lubricant	ISO / ASTM VG32	
Pick-up Filter	Sintered Bronze	

Dimensions

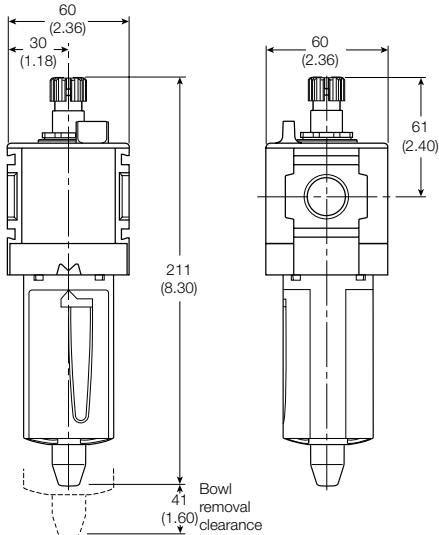

Flow Charts

1/4 Lubricator

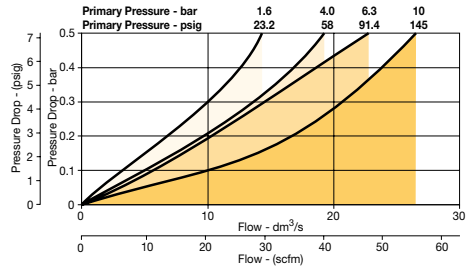

3/8 Lubricator

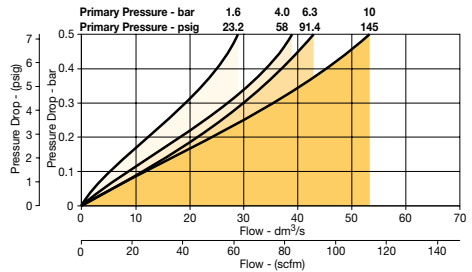

1/2 Lubricator

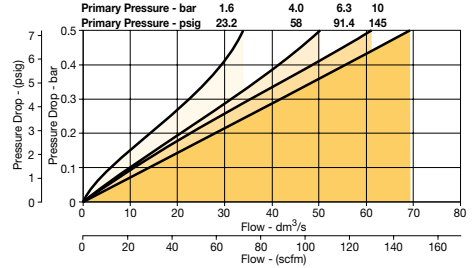

Repair and Service Kits

Plastic bowl / Bowl guard no drain	P32KA00BGN
Drip control assembly	P31KA00PG
Fill plug	P32KA00PL
L-Bracket (fits to body)	P32KA00ML
T-Bracket (fits to body connector)	P32KA00MB
T-Bracket with body connector	P32KA00MT
Body connector	P32KA00CB

Suggested Lubricant F442 Oil

Petroleum based oil of 100 to 200 SUS viscosity at 38°C (100°F) and an aniline point greater than 93°C (200°F) (DO NOT USE OILS WITH ADDITIVES, COMPOUNDED OILS CONTAINING SOLVENTS, GRAPHITE, DETERGENTS, OR SYNTHETIC OILS.)

Standard Lubricator - P33



Symbols



Lubricator with drain

- Integral 1/2" or 3/4" ports (NPT, BSPP & BSPT)
- Robust but lightweight aluminum construction
- Proportional oil delivery over a wide range of air flows
- Finger tip ratchet control for precise oil drip rate adjustment
- Fill from top under system pressure

Options:

P 3 3	L A			L		N	N
Thread type		Port size		Bowl type		Mounting	
BSPP	1	1/2	4	Poly bowl with bowl guard	G	No bracket	N
BSPT	2	3/4	6	Metal bowl with sight gauge	S		
NPT	9						
Type				Drain type			
Oil mist standard sight dome				No drain; closed end			
				L			N

Port size	Description	Order Code†	Flow dm ³ /s (scfm)	Max. bar (psig)	Height mm (inches)	Width mm (inches)	Depth mm (inches)
1/2"	Poly bowl - No drain	P33LA24LGNN	48 (102)	10 (150)	234 (9.21)	73 (2.9)	73 (2.9)
1/2"	Metal bowl - No drain	P33LA24LSNN	48 (102)	17 (250)	234 (9.21)	73 (2.9)	73 (2.9)
3/4"	Poly bowl - No drain	P33LA26LGNN	68 (144)	10 (150)	234 (9.21)	73 (2.9)	73 (2.9)
3/4"	Metal bowl - No drain	P33LA26LSNN	68 (144)	17 (250)	234 (9.21)	73 (2.9)	73 (2.9)

* flow with 6.3 bar (91.3 psig) inlet pressure and 0.34 bar (4.9 psig) pressure drop.

† **Standard part numbers shown in bold. For other models refer to Options chart above.**

Specifications

Flow Capacity*	1/2	48 dm ³ /s (102 scfm)
	3/4	68 dm ³ /s (144 scfm)
Max. Operating Temperature	Plastic Bowl	52°C (125°F)
	Metal Bowl	65.5°C (150°F)
Max. Supply Pressure	Plastic Bowl	10 bar (150 psig)
	Metal Bowl	17 bar (250 psig)
Useful Retention		181 cm ³ (6.1 US oz.)
Port Size	BSPP / BSPT / NPT	1/2, 3/4
Weight		0.47 kg (1.04 lbs)

* Inlet pressure 6.3 bar (91.3 psig). Pressure drop 0.34 bar (4.9 psig).

Materials of Construction

Body	Aluminum	
Body Cap	ABS	
Bowls	Plastic Bowl	Polycarbonate
	Metal Bowl	Aluminum
Seals	Plastic Bowl	Nitrile
	Metal Bowl	Nitrile
Sight Dome	Polycarbonate	
Sight Gauge	Metal Bowl	Polycarbonate
Suggested Lubricant	ISO / ASTM VG32	
Pick-up Filter	Sintered Bronze	

Flow Charts

1/2 Lubricator

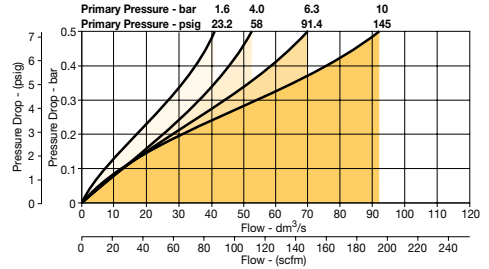

3/4 Lubricator

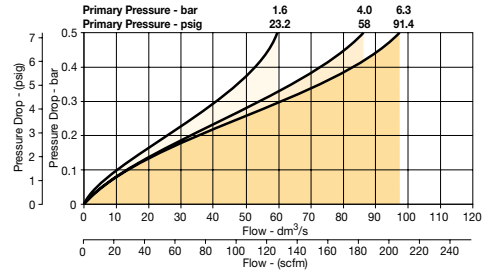

Dimensions

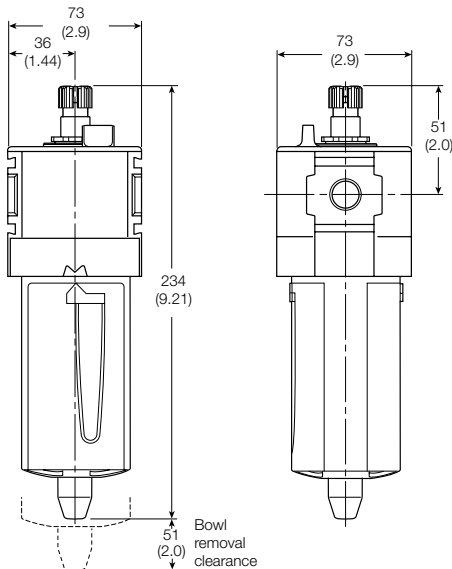

Repair and Service Kits

Plastic bowl / Bowl guard no drain	P33KA00BGN
Drip control assembly	P31KA00PG
Fill plug	P32KA00PL
L-Bracket (fits to body)	P33KA00ML
T-Bracket (fits to body connector)	P32KA00MB
T-Bracket with body connector	P32KA00MT
Body connector	P32KA00CB

Suggested Lubricant F442 Oil

Petroleum based oil of 100 to 200 SUS viscosity at 38°C (100°F) and an aniline point greater than 93°C (200°F) (DO NOT USE OILS WITH ADDITIVES, COMPOUNDED OILS CONTAINING SOLVENTS, GRAPHITE, DETERGENTS, OR SYNTHETIC OILS.)



P31P Series
Bottom exhaust



P32P Series
Bottom exhaust

- Very fast response times
- Accurate output pressure
- Micro parameter settings
- Selectable I/O parameters
- Quick, full flow exhaust
- LED display indicates output pressure
- No air consumption in steady state
- Multiple mounting options
- Protection to IP65
- P31P flows to 19 dm³/s (40 scfm)
- P32P flows to 57 dm³/s (120 scfm)

Order Key

P3	PA	1	A	2	1	A
-----------	-----------	----------	----------	----------	----------	----------

Body size

Global Mini (1/4")	1
Global Compact (1/2")	2

Thread type

BSPP	1
BSPT	2
NPT	9

Port size

Global Mini (1/4")	2
Global Compact (1/2")	4

Version

Bottom ported exhaust (NC)	A
Bottom ported forced exhaust (NO)*	E

Pressure Range

0 - 2 bar (0-29 psig)	Z
0 - 10 bar (0-145 psig)	D

Power supply

24 volts	2
----------	----------

Control Signal

0-10 V [†]	V
---------------------	----------

† Factory setting is 0-10 V control signal. 4-20 mA control signal available via parameter 4 on keypad.

Output Signal

Digital, PNP	D
PNP or 0-10V	P
NPN or 0-10V	N
4-20mA fixed	M

D) Digital PNP output only, no analog output selectable
P) Digital PNP and analogue 0-10V outputs selectable, by means of parameter 6. (Factory default 0-10V)
N) Digital NPN and analog 0-10 V outputs selectable by means of parameter 6. (Factory default 0-10V)
M) Analog 4-20mA output only.
Note: On all analog outputs the F.S. value can be adjusted by means of parameter 8

Input connector

M12 (4 pin)	1
-------------	----------

* When the supply voltage is lost the unit will automatically exhaust the regulated pressure to 0 bar (atmospheric pressure)

P31P Mounting brackets

Order Code	Description
P3HKA00ML	L-Bracket mounting kit
P3HKA00MC	Foot bracket mounting kit

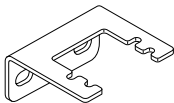

L-Bracket

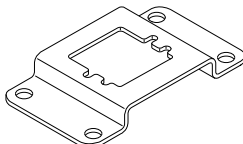

Foot Bracket

P32P Mounting brackets

Order Code	Description
P3KKA00ML	L-Bracket mounting kit
P3KKA00MC	Foot bracket mounting kit

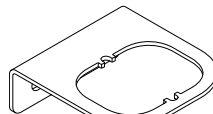

L-Bracket

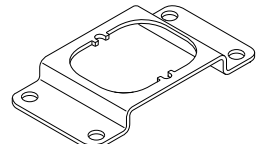

Foot Bracket

Cables

Order Code	Description
CB-M12-4P-2M	2 mtr. cable with moulded straight M12x1 connector

Note:

These brackets fit both Proportional Regulators and Combined Soft Start & Dump Valves.

Technical Information

Working medium

Compressed air or inert gasses, filtered to 40µ.

Supply pressure

Max. Operating Pressure:

2 bar unit: 3 bar (43.5 psig)

10 bar unit: 10.5 bar (152 psig)

Min. Operating Pressure P2 Pressure + 0.5 bar (7.3 psig)

Pressure control range

Available in three pressure ranges, 0-2 bar (0-29 psig), 0-7 bar (0-101.5 psig) or 0-10 bar (0-145 psig). Pressure range can be changed through the software at all times. (parameter 19)

Temperature range

0°C up to +50°C (32°F up to 122°F)

Weights:

P31P = 0.291 kg (0.64 lbs)

P32P = 0.645 kg (1.42 lbs)

Air consumption

No consumption in stable regulated situation.

Display

The regulator is provided with a digital display, indicating the output pressure, either in bar or psig.

The factory setting is as indicated on the label, can be changed through to software at all times (parameter 14)

Supply voltage

24 VDC +/- 10%

Power consumption

Max. 1.1W with unloaded signal outputs

Control signals

The electronic pressure regulator can be externally controlled through an analogue control signal of either 0-10V or 4-20mA. (parameter 4).

Output signals

As soon as the output pressure is within the signal band a signal is given of 24VDC, PNP Ri = 1 kOhm
Outside the signal band this connection is 0V.

Connections

(In case of output signal (Option D))

Central M12 connector 4-pole

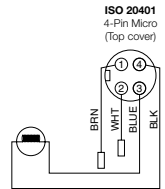

The electrical connections are as follows:

Pin No.	Function	Color	
1	24 V	Supply	Brown
2	0 to 10 V	Control Signal Ri = 100k Ω	White
	4 to 20mA	Control Signal Ri = 500k Ω	
3	0 V (GND)	Supply	Blue
4	24 V	Alarm Output Signal	Black

Schematic

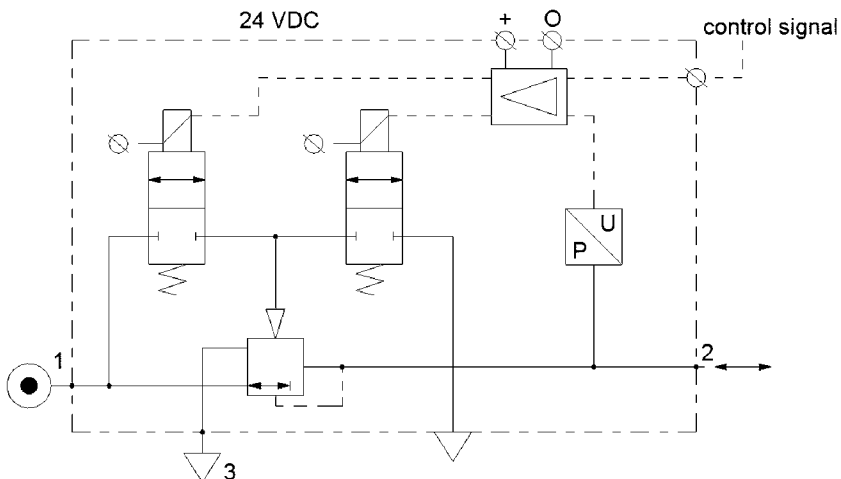

Technical information

Dead band

The dead band is preset at 1.3% of Full Scale*, adjustable via parameter 13.

Accuracy

Linearity: = < 0.3% of Full Scale.*

Proportional band

The proportional band is preset at 10% of Full Scale.*

Fail safe operation

- If the P31P / P32P unit has an "0" or "A" in the 12th digit of the model number
 - When the supply voltage drops, the electronic control reverts to the fail safe mode. The last known output pressure is maintained at approximately the same level depending upon air consumption. The digital display indicates the last known pressure setting.
 - When the supply voltage is reinstated to the correct level, the valve moves from the fail safe mode and the output pressure immediately follows the control signal requirement. The display indicates the actual output pressure.
 - Note: In the event of loss of both power and inlet pressure the unit will exhaust downstream pressure.
- If the P31P / P32P unit has an "E" in the 12th digit of the model number
 - When the supply voltage drops, the electronic control reverts to "Forced Exhaust Mode" and will automatically exhaust the downstream (regulated) pressure.
 - When the supply voltage is reinstated to the correct level the unit will return to normal operation and follows the control signal requirement. The display indicates the actual pressure.
- If the unit has been programmed in manual mode (not with a control signal) the unit will EXHAUST and the regulator will need to be reset when power is applied.

Full exhaust

Complete exhaust of the regulator is defined as P2 ≤ 1% Full Scale

*** Full scale (F.S.)**

For 2 bar (29 psig) versions this will be 2 barr (29 psig), for the 10 bar (145 psig) version full scale will be 10 bar (145 psig).

Degree of protection

IP65

EU conformity

CE: standard

EMC: according to directive 89/336/EEC

The new pressure regulator is in accordance with:

- EN 61000-6-1:2001** **EN 61000-6-2:2001**
- EN 61000-6-3:2001** **EN 61000-6-4:2001**

These standards ensure that this unit meets the highest level of EMC protection.

Mounting position

Preferably vertical, with the cable gland on top.

Materials: P31P & P32P

- Magnet Core Steel
- Solenoid Valve Poppet FPM
- Solenoid Valve Housing Techno Polymer
- Regulator Body (P31P & P32P versions) Aluminium
- Regulator Top Housing Nylon
- Valve Head Brass & NBR
- Remaining Seals NBR

Advanced functionality

Pilot valve protection

When the required output pressure can not be achieved because of a lack of input pressure the unit will open fully and will display NoP. Approximately every 10 seconds the unit will retry. The output pressure will then be approximately equal to the inlet pressure. As soon as the input pressure is back on the required level, the normal control function follows.

Safety exhaust

Should the **control signal** fall below 0.1 volts the valve will automatically dump downstream system pressure .

Input protection

The unit has built-in protection against failure and burnout resulting from incorrect input value, typically:

The 24VDC supply is incorrectly connected to the setpoint input, the display will show 'OL', as an overload indication. The unit will need to be rewired and when correctly connected will operate normally.

The overload indicator 'OL' will also appear should the wrong input value be applied or the wrong input value be programmed: 4 - 20m instead of 0 - 10V. To correct this a different set point value should be input or the unit reprogrammed to correct the set point value acceptance. (via parameter 4).

Response time	P31P	P32P
2 to 4 bar	25 msecs	35 msecs
1 to 6 bar	55 msecs	135 msecs
4 to 2 bar	70 msecs	85 msecs
6 to 1 bar	80 msecs	225 msecs

To fill volume of:
 100cm³ - P31P
 330cm³ - P32P
 connected to the outlet of the regulator.

Settings

The regulator is pre-set at the factory. If required, adjustments can be made.

Flow Charts

P31P Regulator 1/4" Ports

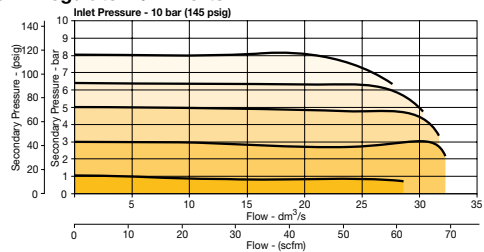

P32P Regulator 1/2" Ports

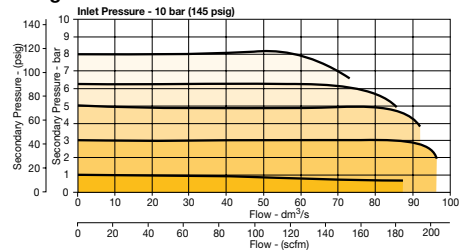

How to change parameters

Pressing the Accept key “acc” for more than 3 seconds, will activate parameter change mode. The user can then select the parameters by pressing up or down key. (display will show Pxx). When parameter number is correct, pressing accept again will enter parameter number.(display will show parameter value).

Pressing the up or down key will change the parameter itself. (display will flash indicating parameter editing mode). Pressing the accept key will accept the new parameter value. (all digits will flash whilst being accepted).

After releasing all keys , the next parameter number will be presented on the display. (you may step to the next parameter). When no key is pressed, after 3 seconds the display will show the actual output pressure.

When the unit is initially powered up allow approximately 10 seconds for the unit to “boot-up” before changing parameter settings.

Only parameter numbers 0, 4, 6, 8, 9, 14, 18, 19, 20, 12, 13 and 21 are accessible to edit. All other parameters are fixed.

Manual mode:















When keys DOWN and UP are pressed during startup, (connecting to the 24V power supply) manual mode is activated. This means that the user is able to in/decrease the output pressure of the regulator, by pressing the UP or DOWN key. During this action the display will blink, indicating that the manual mode is activated. After powering up again, the unit will revert back to normal mode.

Back to Factory Setting

After start up. (Power is on)















Entering this value in parameter 0 will store the calibrated factory data into the working parameters.

(Default calibration data is used)

Parameter Number 0 – Reset Back to Factory Settings						
Step	1	2	3	4	5	
Press 	 3-6 seconds	 or 		 or 		
Until Display Reads			 Flashing Decimal	 Flashing Decimal	 Flashing	
Description	Accesses changeable parameters.	Accesses parameter no. 0.	Displays current parameter value.	Edits parameter. 3 = standard factory settings. If other than 3, use Up or Down Arrow and accept 3	Accepts and saves new parameter setting.	Sequences to next parameter.

Set Control Signal

The unit is factory set for 0-10 V control signal. If 4-20 mA control signal is required, change parameter 4.

Parameter Number 4 – Set Control Signal in Volts or Milliamps						
Step	1	2	3	4	5	
Press 	 3-6 seconds	 or 		 or 		
Until Display Reads			 Flashing Decimal	 Flashing Decimal	 Flashing	
Description	Accesses changeable parameters.	Accesses parameter no. 4.	Displays current parameter value. 1 = V 0 = mA	Edits parameter.	Accepts and saves new parameter setting.	Sequences to next parameter.

Set Output Signal

Parameter 6 is used to set the type of output signal to your PLC.
This parameter is used as follows:

Output Signal option "0" = Digital Output – PNP

- Factory set at "0" Non Adjustable

Output Signal option "P" = Digital PNP or Analog 1-10V

- Factory set at "1" for Analog Signal
- Convert to Digital PNP by changing parameter to "0" setting











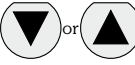

Output Signal option "N" = Digital NPN or Analog 1-10V

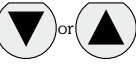
- Factory set at "1" Analog Signal
- Convert to Digital NPN by changing parameter to "0"

Output Signal option "M" = Analog 4-20 mA

- Factory set at "2" Non Adjustable

Parameter Number 6 – Set Output Signal

Step	1	2	3	4	5	
Press 	 3-6 seconds					
Until Display Reads			 Flashing Decimal	 Flashing Decimal (Value 0, 1 or 2)	 Flashing	
Description	Accesses changeable parameters.	Accesses parameter no. 6.	Displays current parameter value. 1 = m factory default for P3H with analog options	Edits parameter. 0 = digital (NPN or PNP) 1 = analog 0..10V 2 = analog 4..20 mA	Accepts and saves new parameter setting.	Sequences to next parameter.











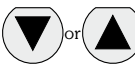

Adjust Span Analog Output Signal

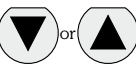
Set value is a % of Full Analog range. As an example for a 0-10V output signal, the original factory setting of 100% will give you an adjustment of 0-10V. If you reset Parameter 8 to 50%, the new output range would be 0-5V or 50% of the full range.

In the event that the output signal is to low, in a certain application, you can adjust it by increasing Parameter 8 to a maximum value of 130% of scale.

Note that all values are nominal and that an actual measurement may be required to ensure signal strength.











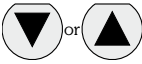

Parameter Number 8 – Adjust Span Analog Output Signal

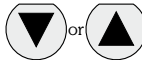
Step	1	2	3	4	5	
Press 	 3-6 seconds					
Until Display Reads			 Flashing Decimal (For 2 bar versions value = 92)	 Flashing Decimal (Value between 0 and 130)	 Flashing	
Description	Accesses changeable parameters.	Accesses parameter no. 8.	Displays current parameter value.	Edits parameter.	Accepts and saves new parameter setting and implements the new analog signal span.	Sequences to next parameter.

Adjust Digital Display

If necessary, adjustments can be made to the digital display when using an external pressure sensor.











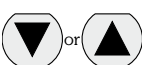

Parameter Number 9 – Adjust Digital Display Value (Pressure Calibration)

Step	1	2	3	4	5	
Press 	 3-6 seconds					
Until Display Reads			 Flashing Decimal	 Flashing Decimal	 Flashing	
Description	Accesses changeable parameters.	Accesses parameter no. 9.	Displays current digital display	Use up or down arrows and accept to adjust the display value if using an external pressure sensor.	Accepts and saves new parameter setting.	Sequences to next parameter.

Set Pressure Scale

Units with NPT port threads are supplied with a factory set psig pressure scale. Use parameter 14 to change scale to bar.











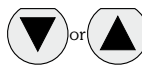

Parameter Number 14 – Set Pressure Scale in psig or bar

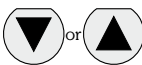
Step	1	2	3	4	5	
Press 	 3-6 seconds					
Until Display Reads			 Flashing Decimal	 Flashing Decimal	 Flashing	
Description	Accesses changeable parameters.	Accesses parameter no. 14.	Displays current parameter value. 1 = psig 0 = bar 2 = MPA	Edits parameter.	Accepts and saves new parameter setting.	Sequences to next parameter.

Preset Minimum Pressure

If there is a need for a pre-set Minimum pressure, use parameter 18. (Note: preset pressure is affected by % P19.)

Parameter Number 18 – Set Minimum Preset Pressure

Step	1	2	3	4	5	
Press 	 3-6 seconds					
Until Display Reads			 Flashing Decimal	 Flashing Decimal (value between 0 and 200)	 Flashing	
Description	Accesses changeable parameters.	Accesses parameter no. 18.	Displays current parameter value. Incremental value is: 2 bar unit: $x 2 \text{ mbar} \times \% P19$ 10 bar unit: $x 10 \text{ mbar} \times \% P19$	Edits parameter.	Accepts and saves new parameter setting.	Sequences to next parameter.

Set Pressure Correction











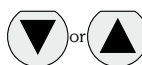

Pressure correction allows the user to set a Maximum pressure as a percentage of secondary pressure F.S.

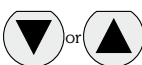
Example: If F.S. is 10 bar, set parameter 19 to 50 for Maximum preset pressure of 5 bar.

Pressure correction also affects the Minimum preset pressure in parameter 18.

Example: If F.S. is 10 bar and parameter 18 is set to a value of 100 (1 bar), and parameter 19 is set to 50%, then the actual Minimum preset pressure seen is 0.5 bar.

Parameter Number 19 – Set Maximum Preset Pressure









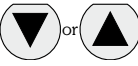

Step	1	2	3	4	5	
Press 	 3-6 seconds					
Until Display Reads			 Flashing Decimal	 Flashing Decimal (value between 0 and 100)	 Flashing	
Description	Accesses changeable parameters.	Accesses parameter no. 19.	Displays current parameter value. Incremental value is: % of F.S.	Edits parameter.	Accepts and saves new parameter setting.	Sequences to next parameter.

Behavior Control

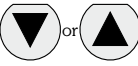
The regulation speed of the pressure regulator can be modified by means of one parameter. (P 20)

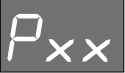
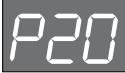
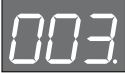
The value in this parameter has a range from 0-5. A higher value indicates slower regulation speed, but will be more stable.

Parameter Number 20 – Set Behavior Control

Step	1	2	3	4	5	
Press 	 3-6 seconds					
Until Display Reads			 Flashing Decimal	 Flashing Decimal (value between 0 and 5)	 Flashing	
Description	Accesses changeable parameters.	Accesses parameter no. 20.	Displays current parameter value.	Edits parameter 0 = custom set* 1 = fastest (narrow proportional band) 2 = fast 3 = normal 4 = slow 5 = slowest (proportional band is broad)	Accepts and saves new parameter setting.	Sequences to next parameter.











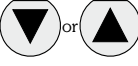

* When the value 0 is entered, you are able to create your own custom settings true parameters 12, 13 and 21.

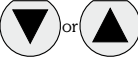
Fine Settings

Set Proportional Band

Proportional band is used for setting the reaction sensitivity of the regulator. The displayed value is X 10 mbar and has a range between 50 (0.5 bar) and 250 (2.5 bar).











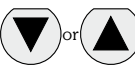

Parameter Number 12 – Set Proportional Band (P20 Must be Set to 0)

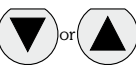
Step	1	2	3	4	5	
Press 	 3-6 seconds					
Until Display Reads			 Flashing Decimal	 Flashing Decimal (value between 50 and 250)	 Flashing	
Description	Accesses changeable parameters.	Accesses parameter no. 12.	Displays current parameter value. Incremental value is: x 10 mbar	Edits parameter.	Accepts and saves new parameter setting.	Sequences to next parameter.

Set Deadband











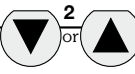

Deadband is the Minimum limit of accuracy at which the regulator is set for normal operation. The displayed value is X 10 mbar and has a range between 4 (40 mbar) and 40 (400 mbar).

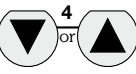
Parameter Number 13 – Set Deadband (P20 Must be Set to 0)







Step	1	2	3	4	5	
Press 	 3-6 seconds					
Until Display Reads			 Flashing Decimal	 Flashing Decimal (value between 4 and 40)	 Flashing	
Description	Accesses changeable parameters.	Accesses parameter no. 13.	Displays current parameter value. Incremental value is x 10 mbar	Edits parameter.	Accepts and saves new parameter setting.	Sequences to next parameter.

Proportional Effect

Parameter Number 21 – Set Proportional Effect (P20 Must be Set to 0)

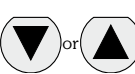
Step	1	2	3	4	5	
Press 						
Until Display Reads			 Flashing Decimal	 Flashing Decimal (value between 5 and 100)	 Flashing	
Description	Accesses changeable parameters.	Accesses parameter no. 21.	Displays current parameter value.	Edits parameter. 5 = fastest regulation 100 = slowest regulation.	Accepts and saves new parameter setting.	Sequences to next parameter.

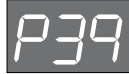
Parameter Number 39 – Displays Current Software Version

Step	1	2	3	
Press 	 3-6 seconds			
Until Display Reads			 Flashing Decimal	
Description	Accesses changeable parameters.	Accesses parameter no. 39.	Displays current parameter value. XXX = current software version	

P31P

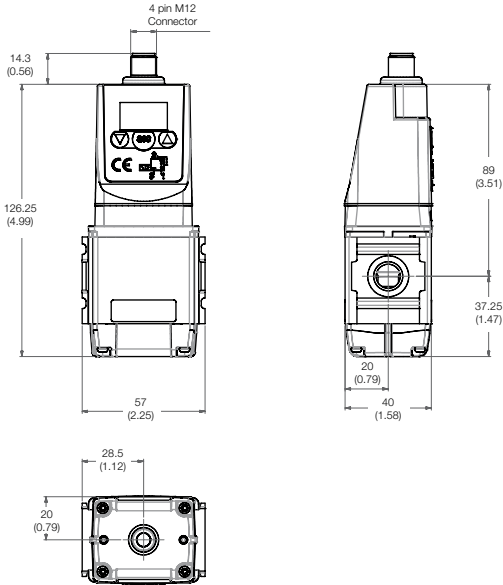

L-Bracket

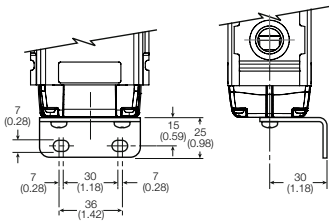

Foot Bracket

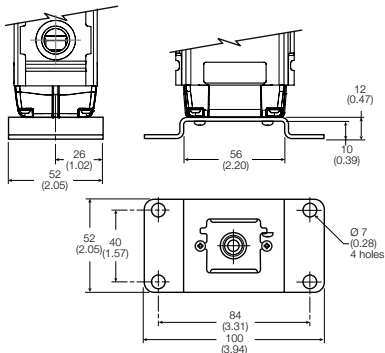

Dimensions are in mm (Inches)

P32P

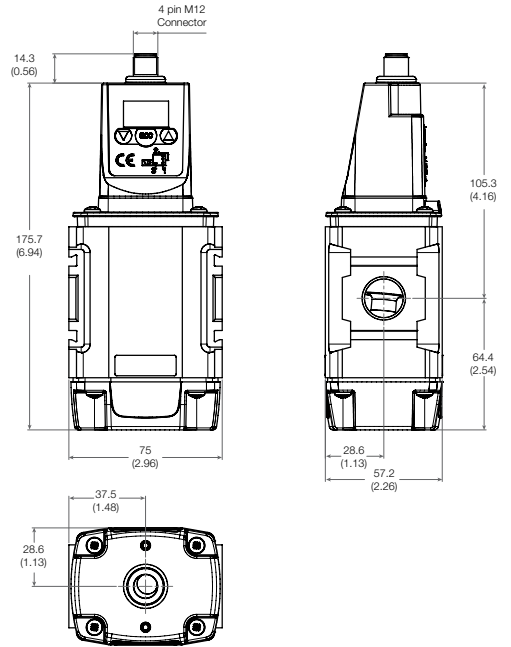

L-Bracket

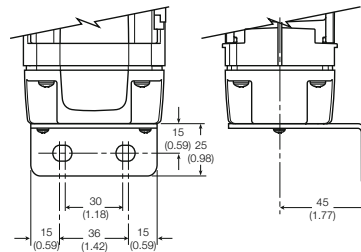

Foot Bracket

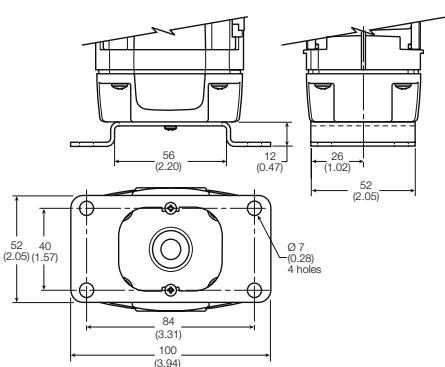

Combined Soft Start / Dump Valve



Parker Global Series Combined Soft Start / Dump Valves, provide for the safe introduction of pressure to machines or systems. Soft Start / Dump Valves when set, allow the pressure to gradually build to the set point before fully opening to deliver full flow at line pressure.

Symbols

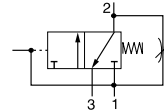

- Modular design with 1/4" or 1/2" integral ports (NPT, BSPP & BSPT)
- Provides for the safe introduction of pressure
- The 3-way, 2-position function automatically dumps downstream pressure on the loss of pilot signal
- Adjustable slow start
- Solenoid or air pilot options
- High flow & exhaust capability
- Silencer included

The controlled introduction of pressure can be an important safety factor and prevent damage to tooling when air pressure is introduced at machine or system start up.

To maintain these units in the open position a pilot supply to the air pilot operated version or an electrical signal to the solenoid operated version must be maintained. The valve will automatically dump when the holding signal is removed.

Options:

P 3		T A							N	Solenoid type only					
Body size		Port size		Pilot type											
Mini (1/4")	1	Mini (1/4")	2	External Air Pilot	P	15mm (P31 series only)	C			24VDC non locking manual override		2CN			
Compact (1/2")	2	Compact (1/2")	4	Solenoid Pilot	S	30mm CNOMO coil (M12 connection)	A			120VAC non locking manual override		3GN			
Thread Type				Actuator interface								120VAC non locking manual override (P31 series only)		1FN	
BSPP (G)	1			15mm solenoid (P31 only)	G										
BSPT	2			30mm solenoid	C										
NPT	9			Threaded air pilot	P										

Note:
P32 unit used for both P32 & P33 series

Compact combined soft start dump valve

Port size	Description	Order Code†	Flow dm ³ /s (scfm)	Max. bar (psig)	Height mm (inches)	Width mm (inches)	Depth mm (inches)	Weight
1/4"	120VAC Solenoid & cable plug	P31TA22SGNA1FN	17 (36)	10 (150)	115.6 (4.5)	57 (2.2)	40 (1.5)	0.37kg (0.8lbs)
1/4"	24VDC Solenoid & cable plug	P31TA22SGNC2CN	17 (36)	10 (150)	166* (6.5)	57 (2.2)	40 (1.5)	0.41kg (0.9lbs)
1/4"	External air pilot operated	P31TA22PPN	17 (36)	17 (250)	115.6 (4.5)	57 (2.2)	40 (1.5)	0.37kg (0.8lbs)
1/2"	120VAC 30mm coil & cable plug incl.	P32TA24SCNA3GN	46 (97)	10 (150)	162.5* (6.3)	88 (3.4)	57.2 (2.2)	0.87kg (1.9lbs)
1/2"	24VDC 30mm coil & cable plug incl.	P32TA24SCNA2CN	46 (97)	10 (150)	227.5* (8.9)	88 (3.4)	57.2 (2.2)	0.91kg (2.0lbs)
1/2"	External air pilot operated	P32TA24PPN	46 (97)	17 (250)	162.5* (6.3)	75 (2.9)	57.2 (2.2)	0.87kg (1.9lbs)

* Includes exhaust silencer. Flow with 6.3 bar (91.3 psig) inlet and 1 bar (14.5 psig) pressure drop.

† Standard part numbers shown in bold. For other models refer to Options chart above.

Technical Information

Fluid:	Compressed air
Max. pressure Solenoid operated:	10 bar (150 psig)
Max. pressure Air Pilot operated:	17 bar (250 psig)
Min. operating pressure:	3 bar (44 psig)
Temperature Max.* Solenoid operated:	50°C (122°F)
Temperature Max.* Air Pilot operated:	80°C (176°F)
Air Pilot port:	1/8"
Exhaust port:	P31 - 1/4" / P32 - 1/2"

Typical flow with 6.3 bar inlet pressure and 1 bar pressure drop:	P31	17 dm ³ /s (36 scfm)
	P32	48 dm ³ /s (97 scfm)

* Air supply must be dry enough to avoid ice formation at temperatures below +2°C
Snap pressure: Full flow when downstream pressure reaches 50% of the inlet pressure

Material Specification

Body:	Aluminum
Body cover:	Polyester
Seals:	Nitrile NBR

Mounting Brackets

Description	Order code P31P	Order code P32P
L-Bracket mounting kit	P3HKA00ML	P3KKA00ML
Foot bracket mounting kit	P3HKA00MC	P3KKA00MC

Note:

For solenoid operators and cable plugs (connectors) see pages 68 to 69.

Dimensions

P31

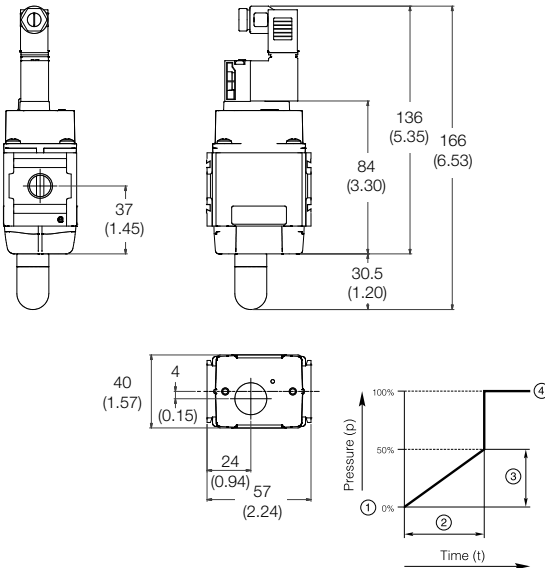

For mounting brackets see page 52

Flow characteristics

1/4 Soft Start & Dump Valve

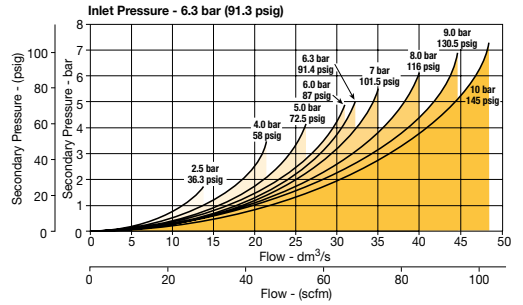

1/2 Soft Start & Dump Valve

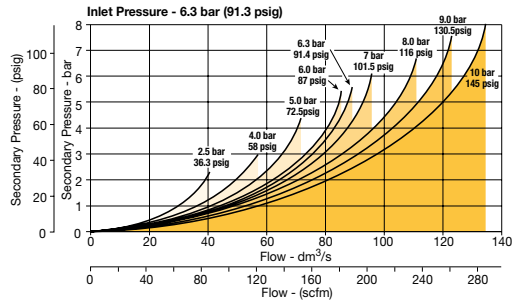

P32

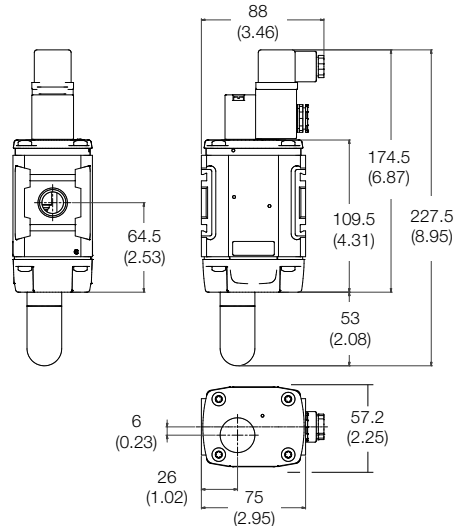

- ① Start signal
- ② Switching time delay
- ③ Gradual pressure build up
- ④ Operating pressure p² (=p¹)

Dump Valve



Remotely operated dump valves automatically shut off upstream pressure and exhaust the downstream pressure when the pilot pressure is released.

Symbols

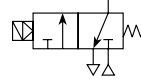

- Modular design with 1/4" or 1/2" integral ports (NPT, BSPP & BSPT)
- Provides for the safe introduction of pressure
- The 3-way, 2-position function automatically dumps downstream pressure on the loss of pilot signal
- Adjustable slow start
- Solenoid or air pilot options
- High flow & exhaust capability
- Silencer included

To maintain these units in the open position a pilot supply to the air pilot operated version or an electrical signal to the solenoid operated version must be maintained. The valve will automatically dump when the holding signal is removed.

Options:

P 3		D A							N	Solenoid type only		
Body size		Port size		Pilot type		15mm (P31 series only)		C	24VDC non locking manual override		2CN	
Mini (1/4")	1	Mini (1/4")	2	External Air Pilot	P	30mm CNOMO coil	A	120VAC non locking manual override		3GN		
Compact (1/2")	2	Compact (1/2")	4	Solenoid Pilot	S	30mm CNOMO coil (M12 connection)	D	120VAC non locking manual override (P31 series only)			1FN	
Thread Type				Actuator interface								
BSPP (G)	1			15mm solenoid (P31 only)	G							
BSPT	2			30mm solenoid	C							
NPT	9			Threaded air pilot	P							

Note:
P32 unit used for both P32 & P33 series

Remote operated dump valve

Port size	Description	Order Code†	Flow dm ³ /s (scfm)	Max. bar (psig)	Height mm (inches)	Width mm (inches)	Depth mm (inches)	Weight
1/4"	120VAC Solenoid & cable plug	P31DA22SGNA1FN	17 (36)	10 (150)	115.6 (4.5)	57 (2.2)	40 (1.5)	0.37kg (0.8lbs)
1/4"	24VDC Solenoid & cable plug	P31DA22SGNC2CN	17 (36)	10 (150)	166* (6.5)	57 (2.2)	40 (1.5)	0.41kg (0.9lbs)
1/4"	External air pilot operated	P31DA22PPN	17 (36)	17 (250)	115.6 (4.5)	57 (2.2)	40 (1.5)	0.37kg (0.8lbs)
1/2"	120VAC 30mm coil & cable plug incl.	P32DA24SCNA3GN	51 (108)	10 (150)	162.5* (6.3)	75 (2.9)	57.2 (2.2)	0.69kg (1.5lbs)
1/2"	24VDC 30mm coil & cable plug incl.	P32DA24SCNA2CN	51 (108)	10 (150)	227.5* (8.9)	75 (2.9)	57.2 (2.2)	0.91kg (2.0lbs)
1/2"	External air pilot operated	P32DA24PPN	51 (108)	17 (250)	162.5*(6.3)	75 (2.9)	57.2 (2.2)	0.87kg (1.9lbs)

* Includes exhaust silencer

† Standard part numbers shown in bold. For other models refer to Options chart above.

Technical Information

Fluid:	Compressed air
Max. pressure Solenoid operated:	10 bar (150 psig)
Max. pressure Air Pilot operated:	17 bar (250 psig)
Min. operating pressure:	3 bar (44 psig)
Temperature Max.* Solenoid operated:	50°C (122°F)
Temperature Max.* Air Pilot operated:	80°C (176°F)
Air Pilot port:	1/8"
Exhaust port:	P31 - 1/4" / P32 - 1/2"

Typical flow with 6.3 bar inlet pressure and 1 bar pressure drop:	P31	17 dm ³ /s (36 scfm)
	P32	51 dm ³ /s (108 scfm)

* Air supply must be dry enough to avoid ice formation at temperatures below +2°C
 Snap pressure: Full flow when downstream pressure reaches 50% of the inlet pressure

Material Specification

Body:	Aluminum
Body cover:	Polyester
Seals:	Nitrile NBR

Mounting Brackets

Description	Order code P31P	Order code P32P
L-Bracket mounting kit	P3HKA00ML	P3KKA00ML
Foot bracket mounting kit	P3HKA00MC	P3KKA00MC

Note:

For solenoid operators and cable plugs (connectors) see pages 68 to 69.

Dimensions

P31

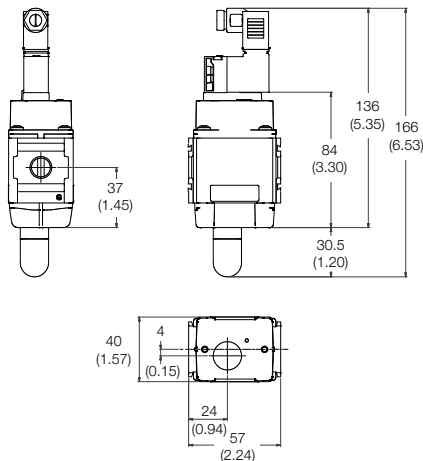

For mounting brackets see page 52

Flow characteristics

1/4 Remote Dump Valve

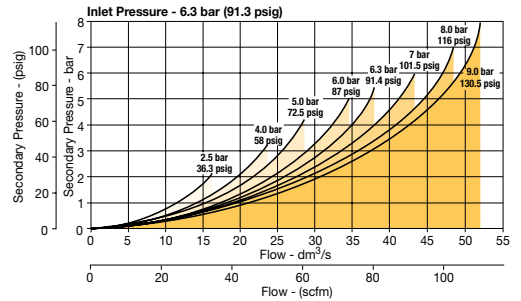

1/2 Remote Dump Valve

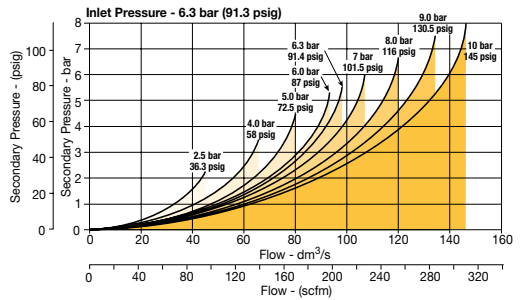

P32

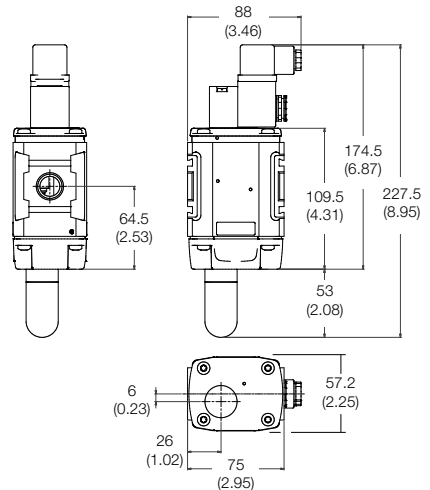

Soft Start Valve



Parker Global Series Soft Start Valves, provide for the safe introduction of pressure to machines or systems. Soft Start Valves, allow the pressure to gradually build to the set point before fully opening to deliver full flow at line pressure.

Symbols

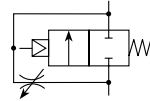

- Modular design with 1/4" or 1/2" integral ports (NPT, BSPP & BSPT)
- The 2-way, 2-position function provides for the safe introduction of pressure
- Adjustable slow start
- Solenoid or air pilot options
- High flow
- Silencer included

The controlled introduction of pressure can be an important safety factor and prevent damage to tooling when air pressure is introduced at machine or system start up.

Note: Soft Start Valves must be installed downstream of a 3/2 valve with exhaust capability

Options:

P3		SA						N	Solenoid type only		
Body size		Port size		Pilot type							
Mini (1/4")		Mini (1/4")		External Air Pilot		15mm (P31 series only)		C		24VDC non locking manual override	
Compact (1/2")		Compact (1/2")		Solenoid Pilot		30mm CNOMO coil		A		2CN	
				Internal Air Pilot		30mm CNOMO coil (M12 connection)		D		120VAC non locking manual override	
Thread Type										3GN	
BSPP (G)										120VAC non locking manual override (P31 series only)	
BSPT										1FN	
NPT											
				Actuator interface							
				Internal Pilot							
				15mm solenoid (P31 only)							
				30mm solenoid							
				Threaded air pilot							

Note:
P32 unit used for both P32 & P33 series

Soft start valve

Port size	Description	Order Code†	Flow dm ³ /s (scfm)	Max. bar (psig)	Height mm (inches)	Width mm (inches)	Depth mm (inches)	Weight
1/4"	120VAC Solenoid & cable plug	P31SA22SGNA1FN	17 (36)	10 (150)	115.6 (4.5)	57 (2.2)	40 (1.5)	0.37kg (0.8lbs)
1/4"	24VDC Solenoid & cable plug	P31SA22SGNC2CN	17 (36)	10 (150)	166.0 (6.5)	57 (2.2)	40 (1.5)	0.41kg (0.9lbs)
1/4"	Internal air pilot operated	P31SA22YON	17 (36)	17 (250)	115.6 (4.5)	57 (2.2)	40 (1.5)	0.37kg (0.8lbs)
1/4"	External air pilot (1/8" threaded)	P31SA22PPN	17 (36)	17 (250)	115.6 (4.5)	57 (2.2)	40 (1.5)	0.37kg (0.8lbs)
1/2"	120VAC 30mm coil & cable plug incl.	P32SA24SCNA3GN	48 (101)	10 (150)	162.5 (6.3)	88 (3.4)	57.2 (2.28)	0.87kg (1.5lbs)
1/2"	24VDC 30mm coil & cable plug	P32SA24SCNA2CN	48 (101)	10 (150)	227.5 (8.9)	88 (3.4)	57.2 (2.28)	0.90kg (2.0lbs)
1/2"	Internal air pilot operated	P32SA24YON	48 (101)	17 (250)	162.5 (6.3)	75 (2.9)	57.2 (2.28)	0.90kg (2.0lbs)
1/2"	External air pilot (1/8" threaded)	P32SA24PPN	48 (101)	17 (250)	162.5 (6.3)	75 (2.9)	57.2 (2.28)	0.87kg (1.5lbs)

† Standard part numbers shown in bold. For other models refer to Options chart above.

Technical Information

Fluid:	Compressed air
Max. pressure Solenoid operated:	10 bar (150 psig)
Max. pressure Air Pilot operated:	17 bar (250 psig)
Min. operating pressure:	3 bar (44 psig)
Temperature Max.* Solenoid operated:	50°C (122°F)
Temperature Max.* Air Pilot operated:	80°C (176°F)
Air Pilot port:	1/8"

Typical flow with 6.3bar inlet pressure and 1 bar pressure drop:	P31	17 dm ³ /s (36 scfm)
	P32	48 dm ³ /s (97 scfm)

* Air supply must be dry enough to avoid ice formation at temperatures below +2°C
Snap pressure: Full flow when downstream pressure reaches 50% of the inlet pressure

Material Specification

Body:	Aluminum
Body cover:	Polyester
Seals:	Nitrile NBR

Mounting Brackets

Description	Order code P31P	Order code P32P
L-Bracket mounting kit	P3HKA00ML	P3KKA00ML
Foot bracket mounting kit	P3HKA00MC	P3KKA00MC

Note:

For solenoid operators and cable plugs (connectors) see pages 68 to 69.

Dimensions

P31

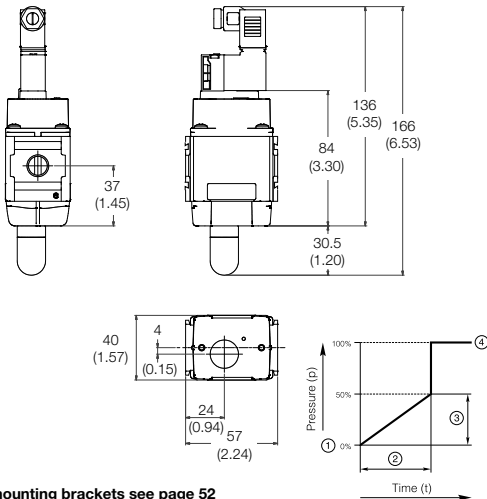

For mounting brackets see page 52

Flow characteristics

1/4 Soft Start Valve

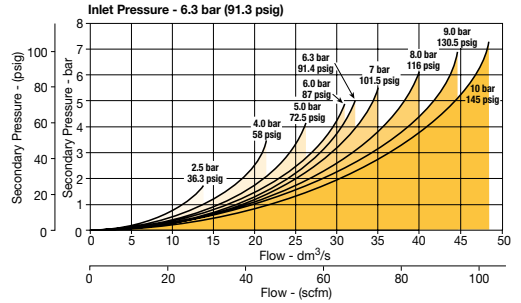

1/2 Soft Start Valve

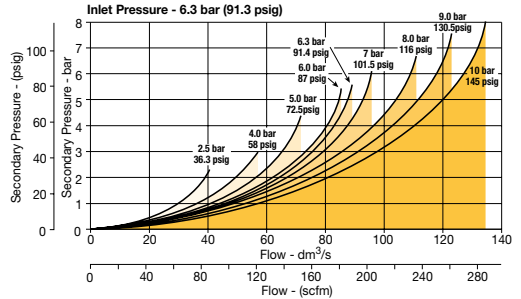

P32

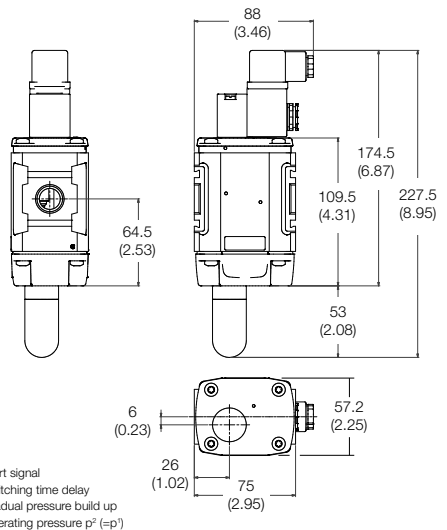

- ① Start signal
- ② Switching time delay
- ③ Gradual pressure build up
- ④ Operating pressure p² (=p¹)

Solenoid Operator - CNOMO

Technical data - Solenoid operators, coil combinations

	NC Normal Operator with 15mm standard coil	NC Normal Operator with 22 x 30 standard coil	NC Normal Operator with 30 x 30 standard coil
Working pressure	0 to 10 bar	0 to 10 bar	0 to 10 bar
Ambient temperature	-15°C to 60°C *	-10°C to 60°C *	-10°C to 60°C *
Power (DC)	1.2W	4.8W	2.7W
Power (AC)	1.6VA	8.5VA	4.9VA
Voltage tolerance	+10%/-15%	+/-10%	+/-10%
Duty cycle	100%	100%	100%
Insulation class	F	F	F
Electric connection	ISO 15217	B Industrial	DIN 43650A
Protection	IP65	IP65	IP65
Approval	UL/CSA		UL/CSA
Working media	All neutral media such as compressed air and inert gases.		

* limited to 50°C if use with 100% duty cycle

Transients

Interrupting the current through the solenoid coil produces momentary voltage peaks which, under unfavourable conditions, can amount to several hundred times the rated operating voltage. Normally, these transients do not cause problems, but to achieve the Maximum life of relays in the circuit (and particularly of transistors, thyristors and integrated circuits) it is desirable to provide protection by means of voltage-dependent resistors (varistors). All connectors/cable plugs EN175301-803 with LED's include this type of circuit protection.

Materials

Pilot Valve

Body:	Polyamide
Armature tube:	Brass
Plunger & core:	Corrosion resistant Cr-Ni steel
Seals:	Fluorocarbon
Screws:	Stainless steel

Coil

Encapsulation material:	Thermoplastic as standard Duroplast for M12 connection
-------------------------	---

P31 Series only - Solenoid coils 15mm NC

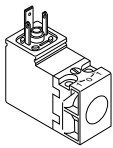

Voltage	Order code Override, blue, non locking flush	Weight (Kg)
24VDC	PS2982B49P	0.038
115VAC 50 Hz / 120VAC 60 Hz	PS2982B53P	0.038

Spare solenoid operators

Base Solenoid pilot operator CNOMO NC

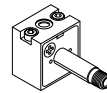

Description	Order code Non-lock manual override	Weight (Kg)
Standard Duty	P2FP23N4B	0.065
No Override	P2FP23N4A	0.065

Note: Solenoid pilot operators are fitted to the Global range. Order the above part numbers for spares. The operators are supplied with mounting screws and interface "O" rings.
Coils and connectors must be ordered separately.

Solenoid coils with M12 connection

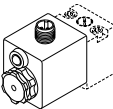

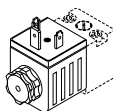

Voltage	Order code	Weight (Kg)
Direct current		
24VDC	P2FC6449	0.065

Solenoid coils with Din A or Industrial B connection



Voltage	22mm x 30mm Order code B Industrial Standard	Weight (Kg)	30mm x 30mm Order code DIN 43650A Standard	Weight (Kg)
Direct current				
24VDC	P2FCB449	0.093	P2FCA449	0.105
Alternative current				
110V 50Hz, 120V 60Hz	P2FCB453	0.093	P2FCA453	0.105

Solenoid connectors / Cable plugs EN175301-803

	Description	Order code 15mm Form C ISO15217	Order code 22mm Form B Industrial	Order code 30mm Form A DIN 43650A
With standard screw 	Standard IP65 without flying lead	PS2932BP	PS2429BP	PS2028BP
	With LED and protection 24VAC/DC	PS294679BP	PS243079BP	PS203279BP
	With LED and protection 110VAC	PS294683BP	PS243083BP	PS203283BP
With cable 	Standard with 2m cable IP65	PS2932JBP	PS2429JBP	PS2028JBP
	24VAC/DC, 2m cable LED and protection IP65	PS2946J79BP	PS2430J79BP	PS2032J79BP
	110VAC/DC, 2m cable LED and protection IP65	PS2946J83BP	PS2430J83BP	PS2032J83BP

Solenoid coil
Dimensions mm (inches)

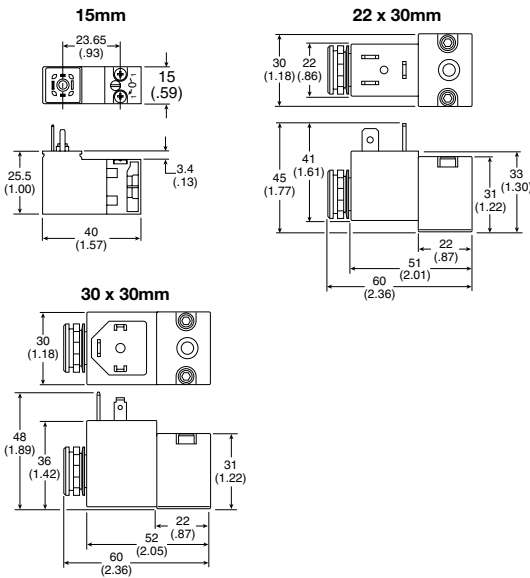

Electrical schematics



PS2028BP	PS243079BP	PS203279BP
PS2028JBP	PS2430J79BP	PS2032J79BP
PS2429BP	PS243083BP	PS293283BP
PS2429JBP	PS2430J83BP	PS2932J83BP
PS2932BP	PS294679BP	PS294683BP
PS2932JBP	PS2946J79BP	PS2946J83BP

Cable plug
Dimensions

15mm ISO 15217
Cable plugs

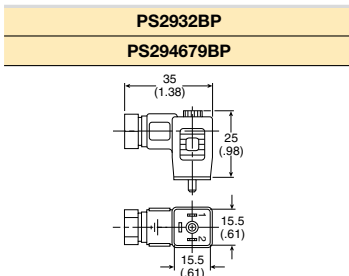

22mm Form B Industrial
Cable plugs

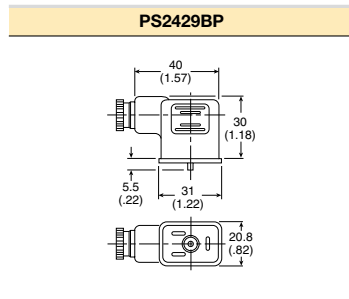

30mm DIN 43650A
Cable plugs

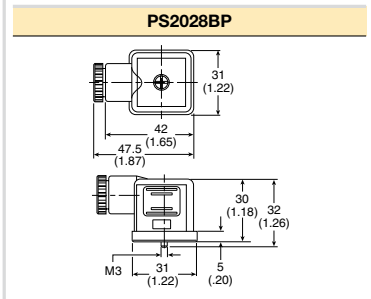

Safety Lockout Valves

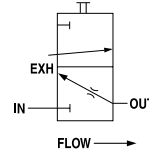
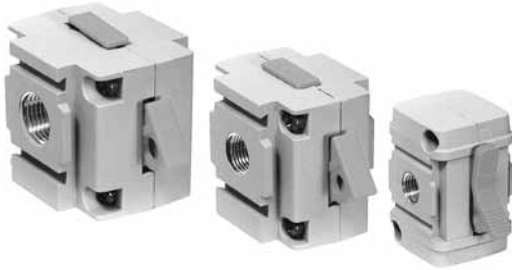

Features

- The Safety Lockout valve is a manually operated, slide-type, 2-position, 3-way valve. In the closed position, downstream air pressure is exhausted to atmosphere.
- The valve slide can be locked in the closed position with a customer supplied padlock.
- The Safety Lockout valves conform to OSHA #29 CFR part 1910 – control of hazardous energy source (lockout / tagout).
- Left to right flow — orange slide
- Right to left — yellow slide

Ordering Information

Model type	Port size	Thread type	Flow dm ³ /s (scfm)	Safety Lockout Valve Flow from left to right	Safety Lockout Valve Flow from right to left
P31	1/4"	NPT	47.2 (100)	P31VA22LSAN	P31VA22LSBN
P32	1/4"	NPT	66.5 (141)	P32VA22LSAN	P32VA22LSBN
	3/8"	NPT	101.9 (216)	P32VA23LSAN	P32VA23LSBN
	1/2"	NPT	128.4 (272)	P32VA24LSAN	P32VA24LSBN
P33	1/2"	NPT	136.9 (290)	P33VA24LSAN	P33VA24LSBN
	3/4"	NPT	141.6 (300)	P33VA26LSAN	P33VA26LSBN

For thread type: BSPP **1**
 BSPT **2**
 NPT **9**

Materials of Construction

Body	Zinc
Blade	Acetal
Seals	Nitrile

Specifications

Max. operating temperature	65.5°C (150°F)
Max. supply pressure	10 bar (150 psig)
Port size	BSPP / BSPT / NPT 1/4, 3/8, 1/2, 3/4
Weight	P31: 0.30 kg (0.66 lbs) P32: 0.34 kg (0.74 lbs) P33: 0.41 kg (0.90 lbs)

Dimensions

P31

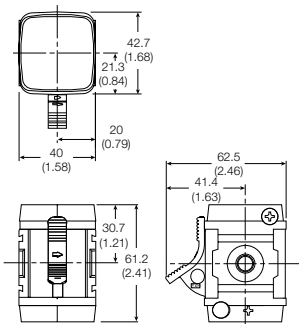

P32

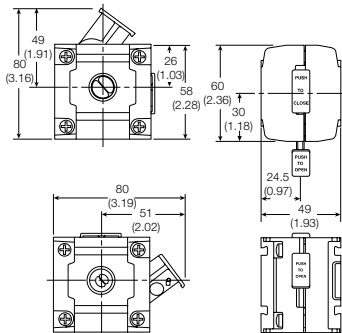

P33

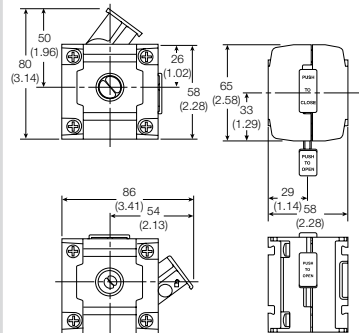

Modular Ball Valve

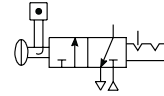

Features

The Modular Ball Valves provide shut off line pressure with a non-sticking 90° turn handle to prevent unauthorised adjustment. When the inlet pressure is turned off the downstream air pressure vents through the exhaust port. The padlock slide may be assembled on either side. It is recommended that this is assembled after mounting.

Note: This padlock slide is a permanent assembly and may not be removed later

Ordering Information

Model type	Port size	Thread type	Flow dm ³ /s (scfm)	Modular Ball Valve Flow from left to right
P31	1/4"	NPT	20 (42.4)	P31VA22LBNN
P32	3/8"	NPT	90 (190.7)	P32VA23LBNN
	1/2"	NPT	122 (258.5)	P32VA24LBNN
P33	1/2"	NPT	265 (561.5)	P33VA24LBNN
	3/4"	NPT	320 (678)	P33VA26LBNN

For thread type: BSPP **1**
 BSPT **2**
 NPT **9**

Specifications

Max. supply pressure		17 bar (250 psig)
Port size	BSPP / BSPT / NPT	1/4, 3/8, 1/2, 3/4
Weight	P31:	0.19 kg (0.41 lbs)
	P32:	0.47 kg (1.00 lbs)
	P33:	0.80 kg (1.70 lbs)

Materials of Construction

Body	Aluminum
Seals	PTFE
Ball	P31 P32 / P33
	Brass Chrome plated brass

Dimensions

P31

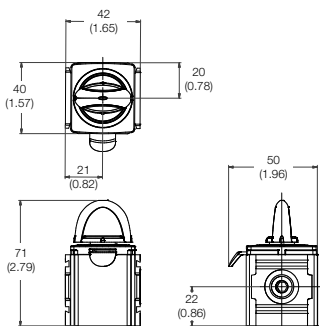

P32

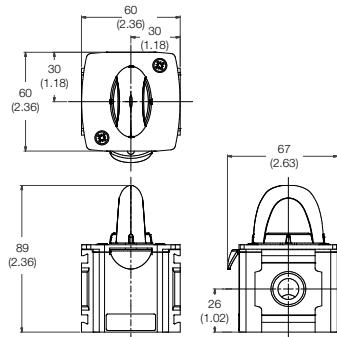

P33

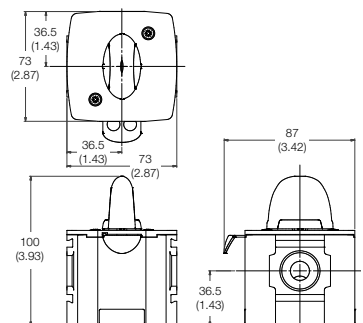

Manifold Blocks

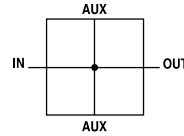

Features

- Available in 1/4" or 3/4" threaded inlet / outlet ports
- Two additional top and bottom auxiliary ports standard
- Can be mounted anywhere in the FRL system
- Includes one pipe plug

Ordering Information

Model type	In / Out port size	Auxiliary port size Top	Auxiliary port size Bottom	Thread type	Order Code
P31	1/4"	1/4"	1/4"	NPT	P31MA22022N
P33	3/4"	1/4"	1/2"	NPT	P33MA26024N

For thread type: BSPP 1
 BSPT 2
 NPT 9

Materials of Construction

Body Aluminum

Note:
P33 unit used for both P32 & P33 series

Specifications

Max. operating temperature	65.5°C (150°F)	
Max. supply pressure	20.7 bar (300 psig)	
Port size (In / Out) NPT / BSPP / BSPT / NPT	P31:	1/4"
	P33:	3/4"
Auxiliary port size - Top NPT / BSPP / BSPT	P31:	1/4"
	P33:	1/4"
Auxiliary port size - Bottom BSPP / BSPT / NPT	P31:	1/4"
	P33:	1/2"
Weight	P31:	0.19 kg (0.26 lbs)
	P33:	0.34 kg (0.42 lbs)

Dimensions

P31

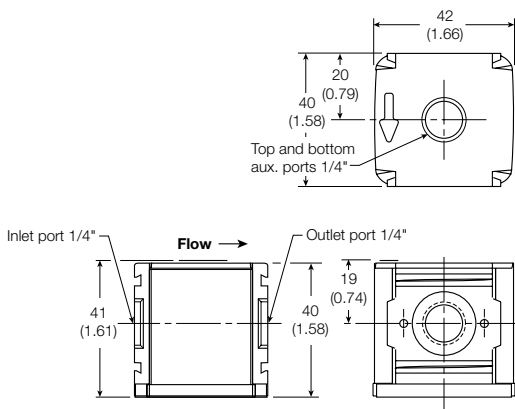

P33

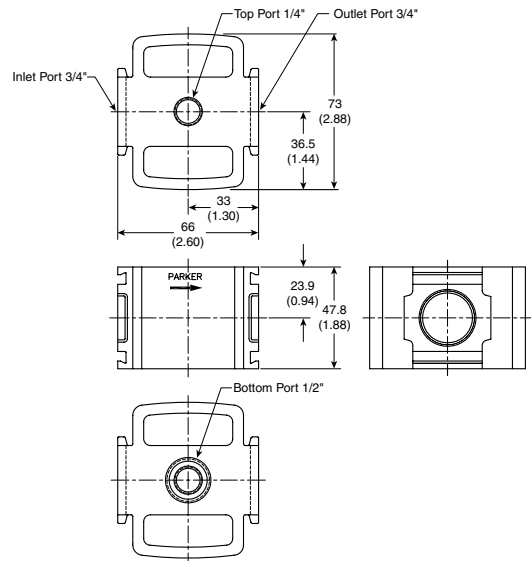

Accessories - P31 Series

C-Bracket

(Fits to filter and lubricator body)

P31KA00MW

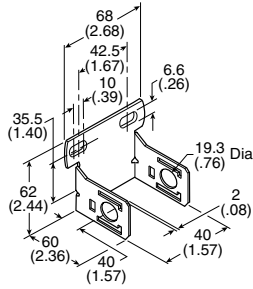

T-Bracket w/ Body Connector

P31KA00MT

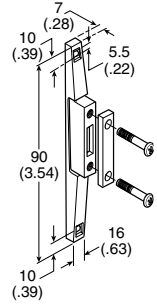

Body Connector

(O-ring not shown)

P31KA00CB

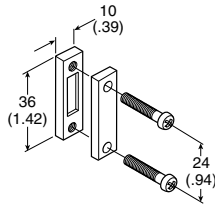

Port Block Kit

- 1/8 NPT..... P31KA91CP
- 1/4 NPT P31KA92CP
- 3/8 NPT..... P31KA93CP
- G 1/8..... P31KA11CP
- G 1/4 P31KA12CP
- G 3/8..... P31KA13CP



Port Block Kit w/ T-Bracket

- 1/8 NPT..... P31KA91CN
- 1/4 NPT P31KA92CN
- 3/8 NPT..... P31KA93CN
- G 1/8..... P31KA11CN
- G 1/4 P31KA12CN
- G 3/8..... P31KA13CN



Angle Bracket

(Fits to regulator and filter/regulator body)

P31KA00MR

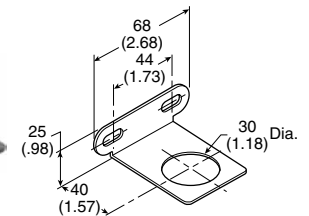

Angle Bracket

Accessories - P32 Series

T-Bracket w/ Body Connector

P32KA00MT

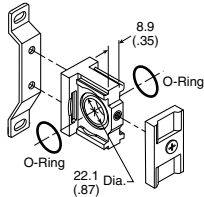

Body Connector

P32KA00CB

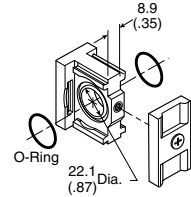

Port Block Kit

- 1/4 NPT..... **P32KA92CP**
- 3/8 NPT..... **P32KA93CP**
- 1/2 NPT..... **P32KA94CP**
- 3/4 NPT..... **P32KA96CP**
- G 1/4 **P32KA12CP**
- G 3/8..... **P32KA13CP**
- G 1/2..... **P32KA14CP**
- G 3/4..... **P32KA16CP**

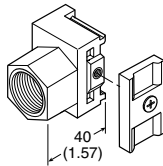

Angle Bracket

(Fits to regulator and filter/regulator bonnet)

P32KA00MR

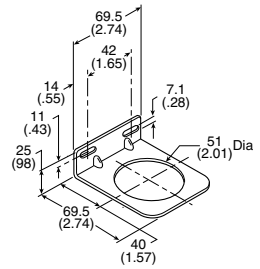

L-Bracket

(Fits to filter and lubricator body)

P32KA00ML

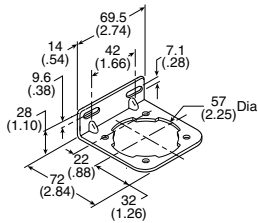

T-Bracket

(fits to body connector or port block)

P32KA00MB

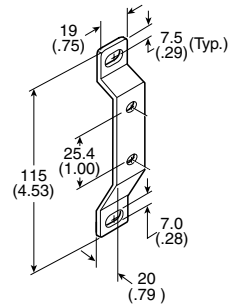

Accessories - P33 Series

T-Bracket w/ Body Connector

P32KA00MT

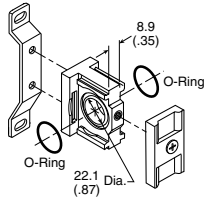

Body Connector

P32KA00CB

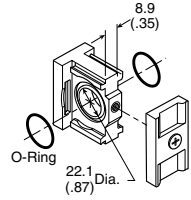

Port Block Kit

- 1/4 NPT.....P32KA92CP
- 3/8 NPT.....P32KA93CP
- 1/2 NPT.....P32KA94CP
- 3/4 NPT.....P32KA96CP
- G 1/4P32KA12CP
- G 3/8.....P32KA13CP
- G 1/2.....P32KA14CP
- G 3/4.....P32KA16CP

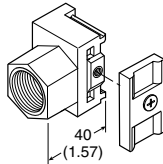

Angle Bracket

(Fits to regulator and filter/regulator bonnet)

P33KA00MR

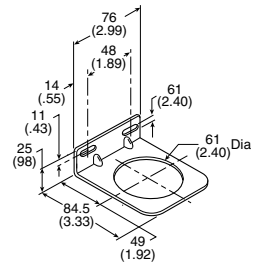

L-Bracket

(Fits to filter and lubricator body)

P33KA00ML

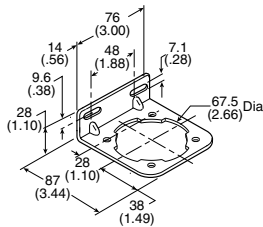



T-Bracket

(fits to body connector or port block)

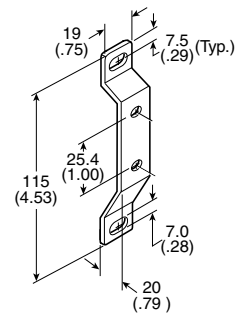







P32KA00MB



Kits

Series	Description	Order Code	
P31 P32 P33	Panel Mount Nut (Plastic)	P31KA00MP P32KA00MP P33KA00MP	
P31 P32 P33	Panel Mount Nut (Aluminum)	P31KA00MM P32KA00MM P33KA00MM	
P31 P32 P33	5 μ Element Kit	P31KA00ESE P32KA00ESE P33KA00ESE	
P31 P32 P33	1 μ Element Kit	P31KA00ES9 P32KA00ES9 P33KA00ES9	
P31 P32 P33	0.01 μ Element Kit	P31KA00ESC P32KA00ESC P33KA00ESC	
P31 P32 P33	Adsorber Element Kit	P31KA00ESA P32KA00ESA P33KA00ESA	
P32 / P33	Auto Drain Kit	P32KA00DA	
P32 / P33	Differential Pressure Indicator Kit	P32KA00RQ	
P31 P32/P33	Fill Plug Kit	P31KA00PL P32KA00PL	
P31 / P32 / P33	Drip Control Assembly Kit	P31KA00PG	

Kits

Series	Description	Order Code	
P31 P32 P33	Plastic Bowl w/ Bowl Guard & Manual Drain	P31KA00BGM P32KA00BGM P33KA00BGM	
P31	Plastic Bowl w/ Bowl Guard & Pulse Drain	P31KA00BGB	
P32 P33	Plastic Bowl w/ Bowl Guard & Auto Drain	P32KA00BGA P33KA00BGA	
P31 P32 P33	Metal Bowl w/o Sight Gauge & Manual Drain	P31KA00BMM P32KA00BMM P33KA00BMM	
P31	Metal Bowl w/o Sight Gauge & Pulse Drain	P31KA00BMB	
P32 P33	Metal Bowl w/o Sight Gauge & Auto Drain	P32KA00BMA P33KA00BMA	
P32 P33	Metal Bowl w/ Sight Gauge & Manual Drain	P32KA00BSM P33KA00BSM	
P32 P33	Metal Bowl w/ Sight Gauge & Auto Drain	P32KA00BSA P33KA00BSA	
P31 P32 P33	Lubricator - Plastic Bowl w/ Bowl Guard No Drain	P31KA00BGN P32KA00BGN P33KA00BGN	
P31 P32 P33	Regulator - Relieving Repair Kit	P31KA00RB P32KA00RB P33KA00RB	
P31 P32 P33	Regulator - Non Relieving Repair Kit	P31KA00RC P32KA00RC P33KA00RC	

Kits

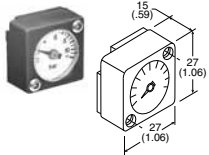
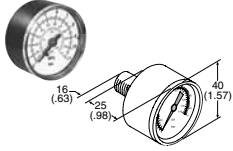
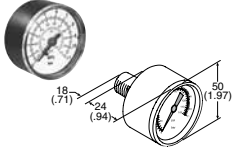
Series	Description	Connection	Order Code
P31 P32 P33	Regulator - Main Adjusting Spring 0-2 bar (0-30 psig) Kit		P31KA00PR P32KA00PR P33KA00PR
P31 P32 P33	Regulator - Main Adjusting Spring 0-4.1 bar (0-60 psig) Kit		P31KA00PS P32KA00PS P33KA00PS
P31 P32 P33	Regulator - Main Adjusting Spring 0-8.6 bar (0-125 psig) Kit		P31KA00PT P32KA00PT P33KA00PT
P32 P33	Regulator - Main Adjusting Spring 0-17 bar (0-250 psig) Kit		P32KA00PV P33KA00PV
P31	Square Flush Mounting Gauge Kit	0-0.4 Mpa 0-1.1 Mpa 0-4.1 bar 0-11 bar 0-60 psig 0-150 psig	K4511SCR04M K4511SCR11M K4511SCR04B K4511SCR11B K4511SCR060 K4511SCR150
			
P31	40mm Round Gauge	0-2 bar/0-0.2 Mpa 0-4.1 bar/0-0.4 Mpa 0-11 bar/0-1.1 Mpa	1/8" 1/8" 1/8" K4515R1402B K4515R1404B K4515R1411B
			
P32 / P33	50mm Round Gauge	0-2 bar/0-0.2 Mpa/0-30 psig 0-4.1 bar/0-0.4 Mpa/0-60 psig 0-11 bar/0-1.1 Mpa/0-160 psig 0-20 bar/0-2 Mpa/0-300 psig	1/4" 1/4" 1/4" 1/4" K4520R1402B K4520R1404B K4520R1411B K4520R1420B
			

Safety Guide For Selecting And Using Pneumatic Division Products And Related Accessories



WARNING:

FAILURE OR IMPROPER SELECTION OR IMPROPER USE OF PNEUMATIC DIVISION PRODUCTS, ASSEMBLIES OR RELATED ITEMS (“PRODUCTS”) CAN CAUSE DEATH, PERSONAL INJURY, AND PROPERTY DAMAGE. POSSIBLE CONSEQUENCES OF FAILURE OR IMPROPER SELECTION OR IMPROPER USE OF THESE PRODUCTS INCLUDE BUT ARE NOT LIMITED TO:

- Unintended or mistimed cycling or motion of machine members or failure to cycle
- Work pieces or component parts being thrown off at high speeds.
- Failure of a device to function properly for example, failure to clamp or unclamp an associated item or device.
- Explosion
- Suddenly moving or falling objects.
- Release of toxic or otherwise injurious liquids or gasses.

Before selecting or using any of these Products, it is important that you read and follow the instructions below.

1. GENERAL INSTRUCTIONS

- 1.1. Scope: This safety guide is designed to cover general guidelines on the installation, use, and maintenance of Pneumatic Division Valves, FRLs (Filters, Pressure Regulators, and Lubricators), Vacuum products and related accessory components.
- 1.2. Fail-Safe: Valves, FRLs, Vacuum products and their related components can and do fail without warning for many reasons. Design all systems and equipment in a fail-safe mode, so that failure of associated valves, FRLs or Vacuum products will not endanger persons or property.
- 1.3. Relevant International Standards: For a good guide to the application of a broad spectrum of pneumatic fluid power devices see: ISO 4414:1998, Pneumatic Fluid Power – General Rules Relating to Systems. See www.iso.org for ordering information.
- 1.4. Distribution: Provide a copy of this safety guide to each person that is responsible for selection, installation, or use of Valves, FRLs or Vacuum products. Do not select, or use Parker valves, FRLs or vacuum products without thoroughly reading and understanding this safety guide as well as the specific Parker publications for the products considered or selected.
- 1.5. User Responsibility: Due to the wide variety of operating conditions and applications for valves, FRLs, and vacuum products Parker and its distributors do not represent or warrant that any particular valve, FRL or vacuum product is suitable for any specific end use system. This safety guide does not analyze all technical parameters that must be considered in selecting a product. The user, through its own analysis and testing, is solely responsible for:
 - Making the final selection of the appropriate valve, FRL, Vacuum component, or accessory.
 - Assuring that all user's performance, endurance, maintenance, safety, and warning requirements are met and that the application presents no health or safety hazards.
 - Complying with all existing warning labels and / or providing all appropriate health and safety warnings on the equipment on which the valves, FRLs or Vacuum products are used; and,
 - Assuring compliance with all applicable government and industry standards.
- 1.6. Safety Devices: Safety devices should not be removed, or defeated.
- 1.7. Warning Labels: Warning labels should not be removed, painted over or otherwise obscured.
- 1.8. Additional Questions: Call the appropriate Parker technical service department if you have any questions or require any additional information. See the Parker publication for the product being considered or used, or call 1-800-CPARKER, or go to www.parker.com, for telephone numbers of the appropriate technical service department.

2. PRODUCT SELECTION INSTRUCTIONS

- 2.1. Flow Rate: The flow rate requirements of a system are frequently the primary consideration when designing any pneumatic system. System components need to be able to provide adequate flow and pressure for the desired application.
- 2.2. Pressure Rating: Never exceed the rated pressure of a product. Consult product labeling, Pneumatic Division catalogs or the instruction sheets supplied for Maximum pressure ratings.
- 2.3. Temperature Rating: Never exceed the temperature rating of a product. Excessive heat can shorten the life expectancy of a product and result in complete product failure.
- 2.4. Environment: Many environmental conditions can affect the integrity and suitability of a product for a given application. Pneumatic Division products are designed for use in general purpose industrial applications. If these products are to be used in unusual circumstances such as direct sunlight and/or corrosive or caustic environments, such use can shorten the useful life and lead to premature failure of a product.
- 2.5. Lubrication and Compressor Carryover: Some modern synthetic oils can and will attack nitrile seals. If there is any possibility of synthetic oils or greases migrating into the pneumatic components check for compatibility with the seal materials used. Consult the factory or product literature for materials of construction.
- 2.6. Polycarbonate Bowls and Sight Gauges: To avoid potential polycarbonate bowl failures:
 - Do not locate polycarbonate bowls or sight gauges in areas where they could be subject to direct sunlight, impact blow, or temperatures outside of the rated range.
 - Do not expose or clean polycarbonate bowls with detergents, chlorinated hydro-carbons, keytones, esters or certain alcohols.
 - Do not use polycarbonate bowls or sight gauges in air systems where compressors are lubricated with fire resistant fluids such as phosphate ester and di-ester lubricants.

- 2.7. Chemical Compatibility: For more information on plastic component chemical compatibility see Pneumatic Division technical bulletins Tec-3, Tec-4, and Tec-5
- 2.8. Product Rupture: Product rupture can cause death, serious personal injury, and property damage.
- Do not connect pressure regulators or other Pneumatic Division products to bottled gas cylinders.
 - Do not exceed the Maximum primary pressure rating of any pressure regulator or any system component.
 - Consult product labeling or product literature for pressure rating limitations.
3. PRODUCT ASSEMBLY AND INSTALLATION INSTRUCTIONS
- 3.1. Component Inspection: Prior to assembly or installation a careful examination of the valves, FRLs or vacuum products must be performed. All components must be checked for correct style, size, and catalog number. DO NOT use any component that displays any signs of nonconformance.
- 3.2. Installation Instructions: Parker published Installation Instructions must be followed for installation of Parker valves, FRLs and vacuum components. These instructions are provided with every Parker valve or FRL sold, or by calling 1-800-CPARKER, or at www.parker.com.
- 3.3. Air Supply: The air supply or control medium supplied to Valves, FRLs and Vacuum components must be moisture-free if ambient temperature can drop below freezing
4. VALVE AND FRL MAINTENANCE AND REPLACEMENT INSTRUCTIONS
- 4.1. Maintenance: Even with proper selection and installation, valve, FRL and vacuum products service life may be significantly reduced without a continuing maintenance program. The severity of the application, risk potential from a component failure, and experience with any known failures in the application or in similar applications should determine the frequency of inspections and the servicing or replacement of Pneumatic Division products so that products are replaced before any failure occurs. A maintenance program must be established and followed by the user and, at Minimum, must include instructions 4.2 through 4.10.
- 4.2. Installation and Service Instructions: Before attempting to service or replace any worn or damaged parts consult the appropriate Service Bulletin for the valve or FRL in question for the appropriate practices to service the unit in question. These Service and Installation Instructions are provided with every Parker valve and FRL sold, or are available by calling 1-800-CPARKER, or by accessing the Parker web site at www.parker.com.
- 4.3. Lockout / Tagout Procedures: Be sure to follow all required lockout and tagout procedures when servicing equipment. For more information see: OSHA Standard – 29 CFR, Part 1910.147, Appendix A, The Control of Hazardous Energy – (Lockout / Tagout)
- 4.4. Visual Inspection: Any of the following conditions requires immediate system shut down and replacement of worn or damaged components:
- Air leakage: Look and listen to see if there are any signs of visual damage to any of the components in the system. Leakage is an indication of worn or damaged components.
 - Damaged or degraded components: Look to see if there are any visible signs of wear or component degradation.
 - Kinked, crushed, or damaged hoses. Kinked hoses can result in restricted air flow and lead to unpredictable system behavior.
 - Any observed improper system or component function: Immediately shut down the system and correct malfunction.
 - Excessive dirt build-up: Dirt and clutter can mask potentially hazardous situations.
- Caution: Leak detection solutions should be rinsed off after use.
- 4.5. Routine Maintenance Issues:
- Remove excessive dirt, grime and clutter from work areas.
 - Make sure all required guards and shields are in place.
- 4.6. Functional Test: Before initiating automatic operation, operate the system manually to make sure all required functions operate properly and safely.
- 4.7. Service or Replacement Intervals: It is the user's responsibility to establish appropriate service intervals. Valves, FRLs and vacuum products contain components that age, harden, wear, and otherwise deteriorate over time. Environmental conditions can significantly accelerate this process. Valves, FRLs and vacuum components need to be serviced or replaced on routine intervals. Service intervals need to be established based on:
- Previous performance experiences.
 - Government and / or industrial standards.
 - When failures could result in unacceptable down time, equipment damage or personal injury risk.
- 4.8. Servicing or Replacing of any Worn or Damaged Parts: To avoid unpredictable system behavior that can cause death, personal injury and property damage:
- Follow all government, state and local safety and servicing practices prior to service including but not limited to all OSHA Lockout Tagout procedures (OSHA Standard – 29 CFR, Part 1910.147, Appendix A, The Control of Hazardous Energy – Lockout / Tagout).
 - Disconnect electrical supply (when necessary) before installation, servicing, or conversion.
 - Disconnect air supply and depressurize all air lines connected to system and Pneumatic Division products before installation, service, or conversion.
 - Installation, servicing, and / or conversion of these products must be performed by knowledgeable personnel who understand how pneumatic products are to be applied.
 - After installation, servicing, or conversions air and electrical supplies (when necessary) should be connected and the product tested for proper function and leakage. If audible leakage is present, or if the product does not operate properly, do not put product or system into use.
 - Warnings and specifications on the product should not be covered or painted over. If masking is not possible, contact your local representative for replacement labels.
- 4.9. Putting Serviced System Back into Operation: Follow the guidelines above and all relevant Installation and Maintenance Instructions supplied with the valve FRL or vacuum component to insure proper function of the system.

The items described in this document and other documents or descriptions provided by Parker Hannifin Corporation, its subsidiaries and its authorized distributors, are hereby offered for sale at prices to be established by Parker Hannifin Corporation, its subsidiaries and its authorized distributors. This offer and its acceptance by any customer ("Buyer") shall be governed by all of the following Terms and Conditions. Buyer's order for any such item, when communicated to Parker Hannifin Corporation, its subsidiaries or an authorized distributor ("Seller") verbally or in writing, shall constitute acceptance of this offer.

1. **Terms and Conditions of Sale:** All descriptions, quotations, proposals, offers, acknowledgments, acceptances and sales of Seller's products are subject to and shall be governed exclusively by the terms and conditions stated herein. Buyer's acceptance of any offer to sell is limited to these terms and conditions. Any terms or conditions in addition to, or inconsistent with those stated herein, proposed by Buyer in any acceptance of an offer by Seller, are hereby objected to. No such additional, different or inconsistent terms and conditions shall become part of the contract between Buyer and Seller unless expressly accepted in writing by Seller. Seller's acceptance of any offer to purchase by Buyer is expressly conditional upon Buyer's assent to all the terms and conditions stated herein, including any terms in addition to, or inconsistent with those contained in Buyer's offer. Acceptance of Seller's products shall in all events constitute such assent.

2. **Payment:** Payment shall be made by Buyer net 30 days from the date of delivery of the items purchased hereunder. Amounts not timely paid shall bear interest at the Maximum rate permitted by law for each month or portion thereof that the Buyer is late in making payment. Any claims by Buyer for omissions or shortages in a shipment shall be waived unless Seller receives notice thereof within 30 days after Buyer's receipt of the shipment.

3. **Delivery:** Unless otherwise provided on the face hereof, delivery shall be made F.O.B. Seller's plant. Regardless of the method of delivery, however, risk of loss shall pass to Buyer upon Seller's delivery to a carrier. Any delivery dates shown are approximate only and Seller shall have no liability for any delays in delivery.

4. **Warranty:** Seller warrants that the items sold hereunder shall be free from defects in material or workmanship for a period of 18 months from date of shipment from Parker Hannifin Corporation. THIS WARRANTY COMPRISES THE SOLE AND ENTIRE WARRANTY PERTAINING TO ITEMS PROVIDED HEREUNDER. SELLER MAKES NO OTHER WARRANTY, GUARANTEE, OR REPRESENTATION OF ANY KIND WHATSOEVER. ALL OTHER WARRANTIES, INCLUDING BUT NOT LIMITED TO, MERCHANTABILITY AND FITNESS FOR PURPOSE, WHETHER EXPRESS, IMPLIED, OR ARISING BY OPERATION OF LAW, TRADE USAGE, OR COURSE OF DEALING ARE HEREBY DISCLAIMED.

NOTWITHSTANDING THE FOREGOING, THERE ARE NO WARRANTIES WHATSOEVER ON ITEMS BUILT OR ACQUIRED WHOLLY OR PARTIALLY, TO BUYER'S DESIGN OR SPECIFICATIONS.

5. **Limitation of Remedy:** SELLER'S LIABILITY ARISING FROM OR IN ANY WAY CONNECTED WITH THE ITEMS SOLD OR THIS CONTRACT SHALL BE LIMITED EXCLUSIVELY TO REPAIR OR REPLACEMENT OF THE ITEMS SOLD OR REFUND OF THE PURCHASE PRICE PAID BY BUYER, AT SELLER'S SOLE OPTION. IN NO EVENT SHALL SELLER BE LIABLE FOR ANY INCIDENTAL, CONSEQUENTIAL OR SPECIAL DAMAGES OF ANY KIND OR NATURE WHATSOEVER, INCLUDING BUT NOT LIMITED TO LOST PROFITS ARISING FROM OR IN ANY WAY CONNECTED WITH THIS AGREEMENT OR ITEMS SOLD HEREUNDER, WHETHER ALLEGED TO ARISE FROM BREACH OF CONTRACT, EXPRESS OR IMPLIED WARRANTY, OR IN TORT, INCLUDING WITHOUT LIMITATION, NEGLIGENCE, FAILURE TO WARN OR STRICT LIABILITY.

6. **Changes, Reschedules and Cancellations:** Buyer may request to modify the designs or specifications for the items sold hereunder as well as the quantities and delivery dates thereof, or may request to cancel all or part of this order, however, no such requested modification or cancellation shall become part of the contract between Buyer and Seller unless accepted by Seller in a written amendment to this Agreement. Acceptance of any such requested modification or cancellation shall be at Seller's discretion, and shall be upon such terms and conditions as Seller may require.

7. **Special Tooling:** A tooling charge may be imposed for any special tooling, including without limitations, dies, fixtures, molds and patterns, acquired to manufacture items sold pursuant to this contract. Such special tooling shall be and remain Seller's property notwithstanding payment of any charges by Buyer. In no event will Buyer acquire any interest in apparatus belonging to Seller which is utilized in the manufacture of the items sold hereunder, even if such apparatus has been specially converted or adapted for such manufacture and notwithstanding any charges paid by Buyer. Unless otherwise agreed, Seller shall have the right to alter, discard or otherwise dispose of any special tooling or other property in its sole discretion at any time.

8. **Buyer's Property:** Any designs, tools, patterns, materials, drawings, confidential information or equipment furnished by Buyer, or any other items which become Buyer's property, may be considered obsolete and may be destroyed by Seller after two (2) consecutive years have elapsed without Buyer placing an order for the items which are manufactured using such property. Seller shall not be responsible for any loss or damage to such property while it is in Seller's possession or control.

9. **Taxes:** Unless otherwise indicated on the face hereof, all prices and charges are exclusive of excise, sales, use, property, occupational or like taxes which may be imposed by any taxing authority upon the manufacture, sale or delivery of the items sold hereunder. If any such taxes must be paid by Seller or if Seller is liable for the collection of such tax, the amount thereof shall be in addition to the amounts for the items sold. Buyer agrees to pay all such taxes or to reimburse Seller therefore upon receipt of its invoice. If Buyer claims exemption from any sales, use or other tax imposed by any taxing authority, Buyer shall save Seller harmless from and against any such tax, together with any interest or penalties thereon which may be assessed if the items are held to be taxable.

10. **Indemnity For Infringement of Intellectual Property Rights:** Seller shall have no liability for infringement of any patents, trademarks, copyrights, trade dress, trade secrets or similar rights except as provided in this Part 10. Seller will defend and indemnify Buyer against allegations of infringement of U.S. patents, U.S. trademarks, copyrights, trade dress and trade secrets (hereinafter "Intellectual Property Rights"). Seller will defend at its expense and will pay the cost of any settlement or damages awarded in an action brought against Buyer based on an allegation that an item sold pursuant to this contract infringes the Intellectual Property Rights of a third party. Seller's obligation to defend and indemnify Buyer is contingent on Buyer notifying Seller within ten (10) days after Buyer becomes aware of such allegations of infringement, and Seller having sole control over the defense of any allegations or actions including all negotiations for settlement or compromise. If an item sold hereunder is subject to a claim that it infringes the Intellectual Property Rights of a third party, Seller may, at its sole expense and option, procure for Buyer the right to continue using said item, replace or modify said item so as to make it noninfringing, or offer to accept return of said item and return the purchase price less a reasonable allowance for depreciation. Notwithstanding the foregoing, Seller shall have no liability for claims of infringement based on information provided by Buyer, or directed to items delivered hereunder for which the designs are specified in whole or part by Buyer, or infringements resulting from the modification, combination or use in a system of any item sold hereunder. The foregoing provisions of this Part 10 shall constitute Seller's sole and exclusive liability and Buyer's sole and exclusive remedy for infringement of Intellectual Property Rights.

If a claim is based on information provided by Buyer or if the design for an item delivered hereunder is specified in whole or in part by Buyer, Buyer shall defend and indemnify Seller for all costs, expenses or judgements resulting from any claim that such item infringes any patent, trademark, copyright, trade dress, trade secret or any similar right.

11. **Force Majeure:** Seller does not assume the risk of and shall not be liable for delay or failure to perform any of Seller's obligations by reason of circumstances beyond the reasonable control of Seller (hereinafter "Events of Force Majeure"). Events of Force Majeure shall include without limitation, accidents, acts of God, strikes or labor disputes, acts, laws, rules or regulations of any government or government agency, fires, floods, delays or failures in delivery of carriers or suppliers, shortages of materials and any other cause beyond Seller's control.

12. **Entire Agreement/Governing Law:** The terms and conditions set forth herein, together with any amendments, modifications and any different terms or conditions expressly accepted by Seller in writing, shall constitute the entire Agreement concerning the items sold, and there are no oral or other representations or agreements which pertain thereto. This Agreement shall be governed in all respects by the law of the State of Ohio. No actions arising out of sale of the items sold hereunder or this Agreement may be brought by either party more than two (2) years after the cause of action accrues.

Parker Worldwide

Europe, Middle East, Africa

AE – United Arab Emirates,

Dubai
Tel: +971 4 8127100
parker.me@parker.com

AT – Austria, Wiener Neustadt

Tel: +43 (0)2622 23501-0
parker.austria@parker.com

AT – Eastern Europe, Wiener Neustadt

Tel: +43 (0)2622 23501 900
parker.easteurope@parker.com

AZ – Azerbaijan, Baku

Tel: +994 50 2233 458
parker.azerbaijan@parker.com

BE/LU – Belgium, Nivelles

Tel: +32 (0)67 280 900
parker.belgium@parker.com

BY – Belarus, Minsk

Tel: +375 17 209 9399
parker.belarus@parker.com

CH – Switzerland, Etoy

Tel: +41 (0)21 821 87 00
parker.switzerland@parker.com

CZ – Czech Republic, Klecany

Tel: +420 284 083 111
parker.czechrepublic@parker.com

DE – Germany, Kaarst

Tel: +49 (0)2131 4016 0
parker.germany@parker.com

DK – Denmark, Ballerup

Tel: +45 43 56 04 00
parker.denmark@parker.com

ES – Spain, Madrid

Tel: +34 902 330 001
parker.spain@parker.com

FI – Finland, Vantaa

Tel: +358 (0)20 753 2500
parker.finland@parker.com

FR – France, Contamine s/Arve

Tel: +33 (0)4 50 25 80 25
parker.france@parker.com

GR – Greece, Athens

Tel: +30 210 933 6450
parker.greece@parker.com

HU – Hungary, Budapest

Tel: +36 1 220 4155
parker.hungary@parker.com

IE – Ireland, Dublin

Tel: +353 (0)1 466 6370
parker.ireland@parker.com

IT – Italy, Corsico (MI)

Tel: +39 02 45 19 21
parker.italy@parker.com

KZ – Kazakhstan, Almaty

Tel: +7 7272 505 800
parker.easteurope@parker.com

NL – The Netherlands, Oldenzaal

Tel: +31 (0)541 585 000
parker.nl@parker.com

NO – Norway, Asker

Tel: +47 66 75 34 00
parker.norway@parker.com

PL – Poland, Warsaw

Tel: +48 (0)22 573 24 00
parker.poland@parker.com

PT – Portugal, Leca da Palmeira

Tel: +351 22 999 7360
parker.portugal@parker.com

RO – Romania, Bucharest

Tel: +40 21 252 1382
parker.romania@parker.com

RU – Russia, Moscow

Tel: +7 495 645-2156
parker.russia@parker.com

SE – Sweden, Spånga

Tel: +46 (0)8 59 79 50 00
parker.sweden@parker.com

SK – Slovakia, Banská Bystrica

Tel: +421 484 162 252
parker.slovakia@parker.com

SL – Slovenia, Novo Mesto

Tel: +386 7 337 6650
parker.slovenia@parker.com

TR – Turkey, Istanbul

Tel: +90 216 4997081
parker.turkey@parker.com

UA – Ukraine, Kiev

Tel: +380 44 494 2731
parker.ukraine@parker.com

UK – United Kingdom, Warwick

Tel: +44 (0)1926 317 878
parker.uk@parker.com

ZA – South Africa, Kempton Park

Tel: +27 (0)11 961 0700
parker.southafrica@parker.com

North America

CA – Canada, Milton, Ontario

Tel: +1 905 693 3000

US – USA, Cleveland

Tel: +1 216 896 3000

Asia Pacific

AU – Australia, Castle Hill

Tel: +61 (0)2-9634 7777

CN – China, Shanghai

Tel: +86 21 2899 5000

HK – Hong Kong

Tel: +852 2428 8008

IN – India, Mumbai

Tel: +91 22 6513 7081-85

JP – Japan, Tokyo

Tel: +81 (0)3 6408 3901

KR – South Korea, Seoul

Tel: +82 2 559 0400

MY – Malaysia, Shah Alam

Tel: +60 3 7849 0800

NZ – New Zealand, Mt Wellington

Tel: +64 9 574 1744

SG – Singapore

Tel: +65 6887 6300

TH – Thailand, Bangkok

Tel: +662 717 8140

TW – Taiwan, Taipei

Tel: +886 2 2298 8987

South America

AR – Argentina, Buenos Aires

Tel: +54 3327 44 4129

BR – Brazil, Sao Jose dos Campos

Tel: +55 12 4009 3500

CL – Chile, Santiago

Tel: +56 2 623 1216

MX – Mexico, Apodaca

Tel: +52 81 8156 6000

VE – Venezuela, Caracas

Tel: +58 212 238 5422

European Product Information Centre

Free phone: 00 800 27 27 5374

(from AT, BE, CH, CZ, DE, DK, EE, ES, FI, FR, IE, IL, IS, IT, LU, MT, NL, NO, PL, PT, RU, SE, SK, UK, ZA)



Parker Korea Ltd.

759-10 Geumui-ri, Jangan-myeon,
Hwaseong-si, Gyeonggi-do,
445-941, Korea

Tel: +82 (0) 31-359-0700

Fax: +82 (0) 31-359-0780

www.parker.com